

FORMAX[®]

6606 Series Inserters

Table of Contents

1	How this Help Works	1
	Help Menu.....	1
	User Guide.....	1
2	Meet your Document System	3
	Introduction.....	3
	System Overview.....	4
	Operating Controls.....	6
	Control Panel.....	7
	Power Up.....	7
	How to Operate the Touch Screen.....	9
	Open a Web Browser.....	11
	What is a Job?.....	11
	Job List.....	12
	Job Overview.....	13
	High Capacity Document Feeder (HCDF).....	15
	Production Feeder (FD 6606-00).....	15
	Thin Booklet Feeder (FD 6606-15).....	16
	Catch Tray.....	17
	Shut Down the System.....	18
3	Working with Jobs	19
	Introduction.....	19
	Use an Existing Job.....	19
	Create a New Job.....	20
	About Automatic Jobs.....	21
	Create an Automatic Job.....	21
	Create a Manual Job.....	23
	Create an Test Mail Set.....	35

Mail Sets.....	41
Change to Another Feeder Tray.....	47
Link Feeder Trays.....	47
Edit a Job.....	48
Save a Job.....	49
Delete or Move an Enclosure.....	50
Copy a Job.....	51
Lock a Job.....	51
Rename a Job.....	53
Delete a Job.....	54
4 Loading the System	55
Document Orientation.....	55
Document Feed Trays.....	56
Load Envelopes.....	66
Adjust the Side Guides and Envelope Separation.....	67
Fill the Sealing Liquid Reservoir.....	68
5 Options	69
Support for Curved Reply Envelopes (option for Thin Booklet Feeder).....	69
Power Stacker Support.....	69
High Capacity Envelope Hopper (FD 6606-30/EF-4).....	70
High Capacity Conveyor Belt (FD 6606-25).....	72
6 Settings menu	74
Open the Settings Menu.....	74
Open the Settings Menu (Supervisor).....	76
Supervisor Settings Menu.....	78
7 Connect the System to the Internet	95
Options for Connection.....	95
Set up a Wired Connection.....	95
Set up a Wireless Connection.....	97
Test the Connection.....	99

8	Reading	100
	Introduction.....	100
	OCR Code Description.....	101
	BCR Code Description.....	104
	OMR Code Description.....	108
	Flex Reading Code Description.....	112
	Create Jobs with Reading.....	113
	Reading Settings.....	119
	Exit Selection with Reading.....	122
9	Operator Maintenance	123
	Maintenance Schedule.....	123
	Clean and Replace Brushes.....	124
	Replace or Clean Moistening Cloth.....	125
	Calibrate Photocells.....	126
10	Fault Finding	127
	Messages.....	127
	Clear Stoppages.....	130
	Operator Troubleshooting.....	136
	Troubleshooting Table.....	137
11	Specifications	142
	Technical Specifications.....	142
	Hopper and Feeder Capacity.....	143
	Configuration Dimensions.....	143
	Document and Insert Specifications.....	143
	Envelope and Document Set Specifications.....	144
	Production Feeder Specifications.....	145
	Thin Booklet Feeder Specifications.....	146
	High Capacity Envelope Hopper Specifications.....	147
	High Capacity Conveyor Belt Specifications.....	148
12	Terminology	149

1 How this Help Works

Help Menu

The help button [?] gives access to help topics via a pull-down menu.

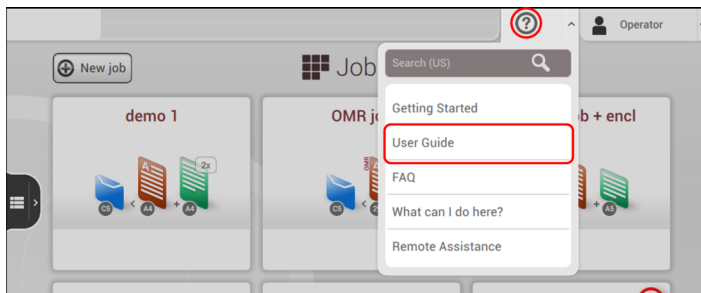

The contents of the help menu can be different for your situation. The help menu can contain the following topics:

- Search; use the search engine to find a specific topic.
- User Guide; user instructions describing how to use the system.
- FAQ's (option); when the system is connected to the internet, frequently asked questions are answered here (option).
- What can I do here; a list with relevant help topics related to the current screen.
- Remote assistance (option); online remote assistance for helpdesk guidance. Call the phone number that is displayed and follow the instructions of the support assistant.

User Guide

You can use this guide as follows:

- Use the contents overview to browse the contents.
- Use the keyword search, to enter a keyword for the search. The information button at the keyword search supplies detailed information on how to optimize the search.

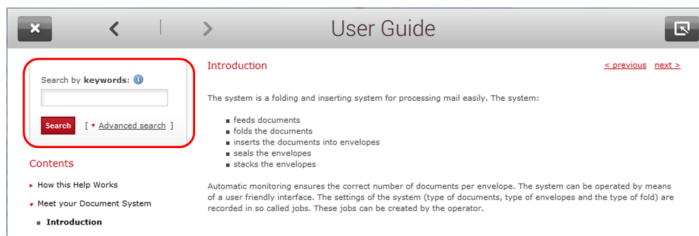

- If necessary, use the advanced search to narrow down your keyword search to better matching results.



English

To navigate through the User Guide:

- Tap to select
- Swipe up/down to scroll
- Double tap to zoom
- Pinch in/out to zoom in/out

See also [How to operate the touchscreen](#) on page 9.

When you use the User Guide, you can minimize it, to operate the system. Use the minimize button to minimize the User Guide.

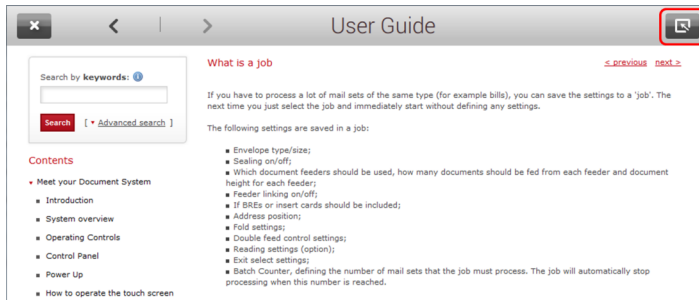

The help button shows a purple color when the User Guide is minimized. When you click the help button, the User Guide is restored.

2 Meet your Document System

Introduction

2

English

The system is a folding and inserting system for processing mail easily. The system:

- feeds documents
- folds the documents
- inserts the documents into envelopes
- seals the envelopes
- stacks the envelopes

Automatic monitoring ensures the correct number of documents per envelope. The system can be operated by means of a user friendly interface. The settings of the system (type of documents, type of envelopes and the type of fold) are recorded in so called jobs. These jobs can be created by the operator.

The system is equipped with a variety of special features, such as:

- [mail set thickness detection](#)
- [job wizard for creating jobs](#)
- [Double Feed Control](#)
- [feeder tray linking](#)
- [feeder tray swapping](#)
- [daily mail](#)
- [Flexible Feeders](#) on page 4
- [Divert Deck](#) on page 4
- [Folding Power](#) on page 4

Operator and supervisor

You can use the system as operator and as supervisor. The supervisor has access to more settings than the operator. You can switch from operator to supervisor in every screen. When you switch to supervisor, you see immediately the result: extra tabs appear for the advanced settings. Also the side menu contains extra functions.

System Overview

2

English

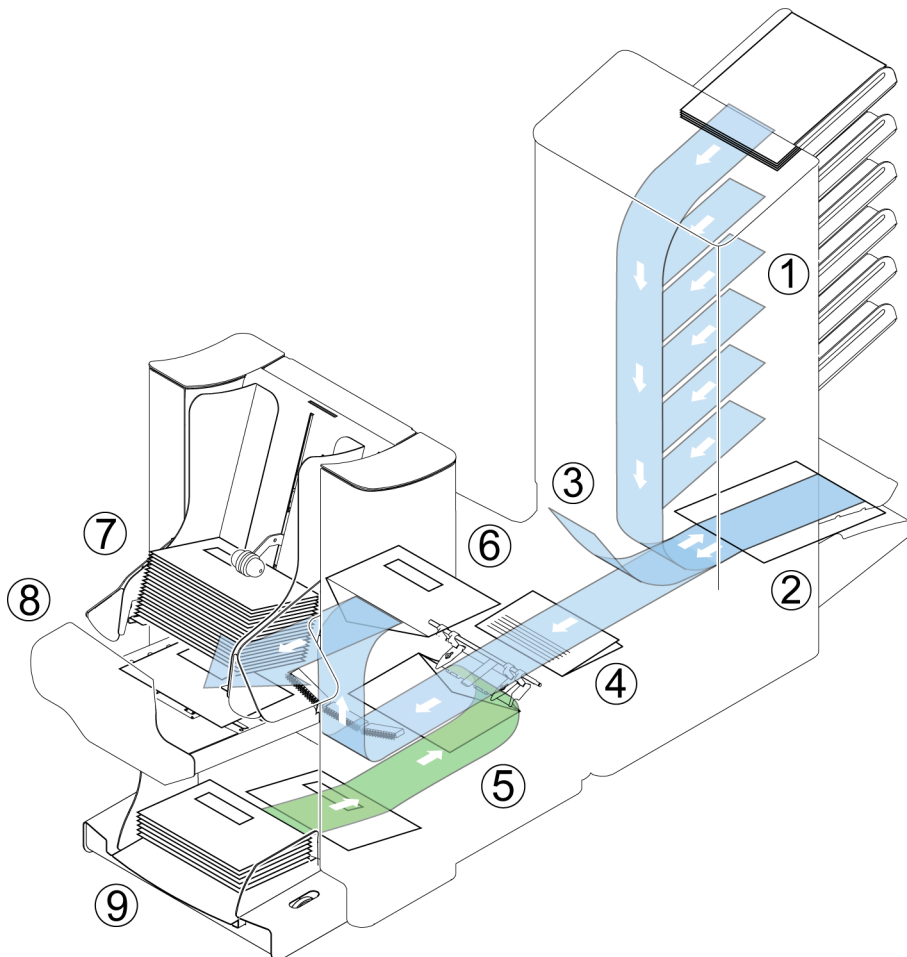

The figure shows an overview of the system.

Document Feeders (1)

The Document Feeders are the feeding part of the system. There are two types of feeders: the automatic and the special feeder. The automatic feeder does not require any adjustments for the separation. From a feeder you can feed one or more documents (multi feed). The feeders have a double feed control (DFC). DFC detects if more documents are fed instead of one.

You can link feeders. This means that two feeders can be linked as pairs. When the first feeder is empty, the system switches to the other feeder. Meanwhile the empty feeder can be refilled without stopping the system.

The upper automatic feeder is equipped with a 'daily mail' function. You can use this feeder to process sets of documents that you cannot process automatically (stapled documents and sets with varying thickness).

Collating Area (2)

All documents of a document set are collated and aligned in the collating area.

Divert Deck(3)

The Divert Deck automatically throws out incorrect sets of documents. In this way the system does not need to stop. Correct sets will be transported to the folding unit.

Folding Unit (4)

The fold unit folds the documents. The following fold types are possible (see [Terminology](#) on page 149):

- No fold
- V-fold
- C-fold
- Z-fold
- Double V-fold

Inserter (5)

After the documents are folded, the documents are transported to the inserter. The inserter inserts the documents into a waiting envelope. The inserter seals the envelope or not, depending on the settings. Automatic monitoring ensures the correct number of inserts per envelope.

Present on Deck (6)

The documents inserted (or not) can leave the inserter from the upper unit (present on deck). This can occur when:

- Clearing the machine;
- Making a test set;
- Depending on the reading code.

Stacker (7)

The documents inserted (or not) are transported to the stacker depending on the programmed job. The stacker automatically stacks inserted documents.

Side exit (8)

The documents inserted are transported to the side exit depending on the programmed job. The side exit can be used for sorting and stacking of documents into the catch tray as well as transporting to the optional conveyor belt or franking/mailing machine.

Envelope Hopper (9)

Envelopes that are placed on a stack by the user, are fed one by one into the system by the envelope hopper.

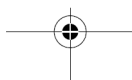

Operating Controls

2
English

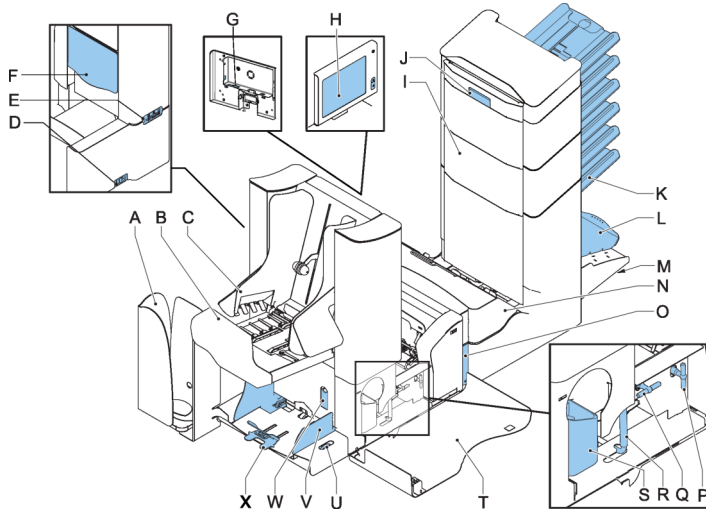

A - catch tray (optional)

B - side exit / stacker unit

C - side guides stacker

D - power inlet, power switch

E - USB (service only)

F - unlocking lever for upper unit

G - USB (2x), RS232 and ethernet

H - control panel

I - vertical transport

J - hand grip vertical transport cover

K - document feed tray

L - collator arm

M - Divert Deck

N - Folding unit

O - locking handle Folding unit

P - handle for manual transport of the envelope

Q - handle for manual transport of the mail set

R - unlocking handle for rollers envelope track

S - sealing liquid reservoir

T - side cover (opened)

U - thumb wheel for side guide adjustment

V - side guides envelope feed tray

W - flap for envelope separation adjustment

X - envelope support

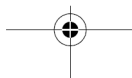

Control Panel



The touch screen is covered with a thin pressure-sensitive layer. To avoid permanent damage of the touch screen, do not use sharp objects to press on the touch screen.

2

The control panel consists of the touch screen and the following buttons:

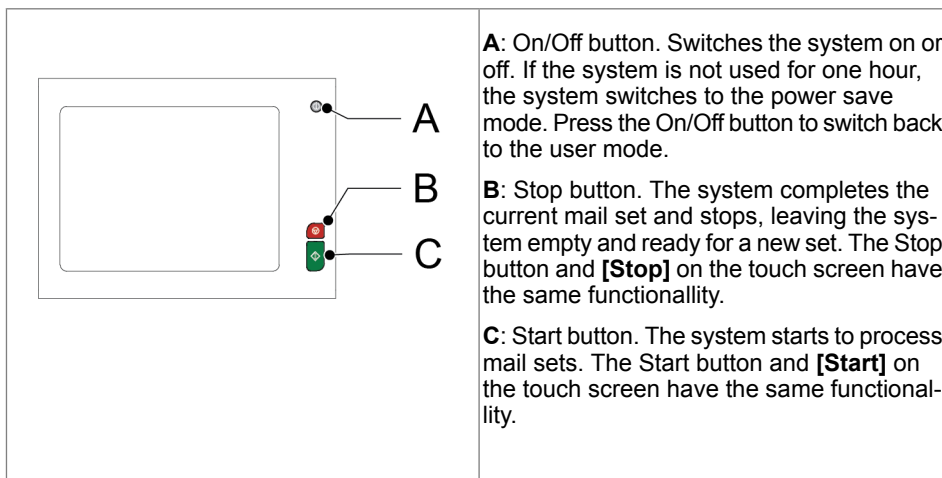

English

Power Up

To start up the system:



You can severely damage the machine if it is connected to the incorrect mains voltage. Before plugging in the machine, check if the local voltage is the same as the voltage mentioned on the type plate.

1. Connect the system to the mains power supply.

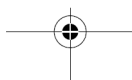

2. Use the power switch **A** to switch the system on. The power switch is located on the back of the system.

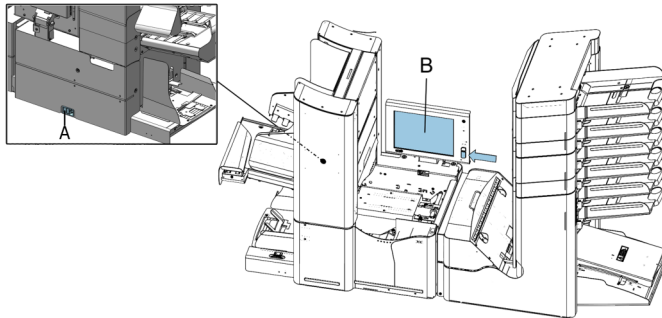

3. Press the on/off button  next to the display **B**.
The touch screen shows the Job list screen.

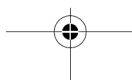
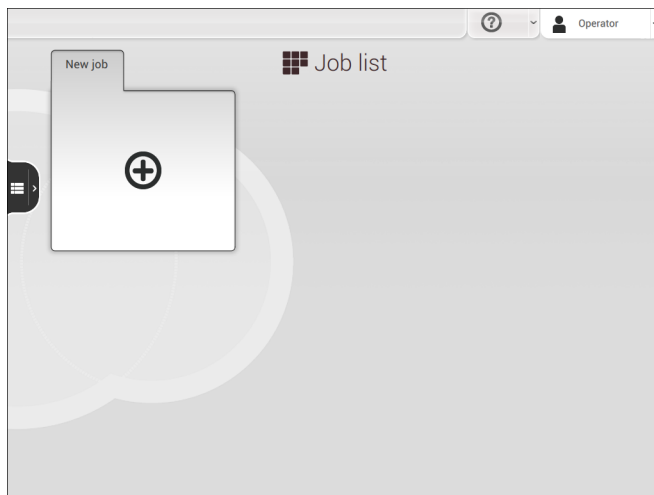

How to Operate the Touch Screen

You can operate the touch screen like a tablet:

- Tap: touch and release the screen with your finger

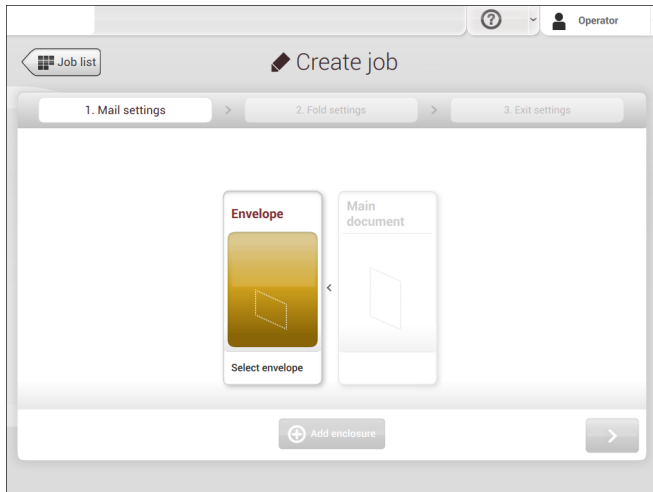

- Swipe: touch the screen, hold it and move your finger(s) left or right

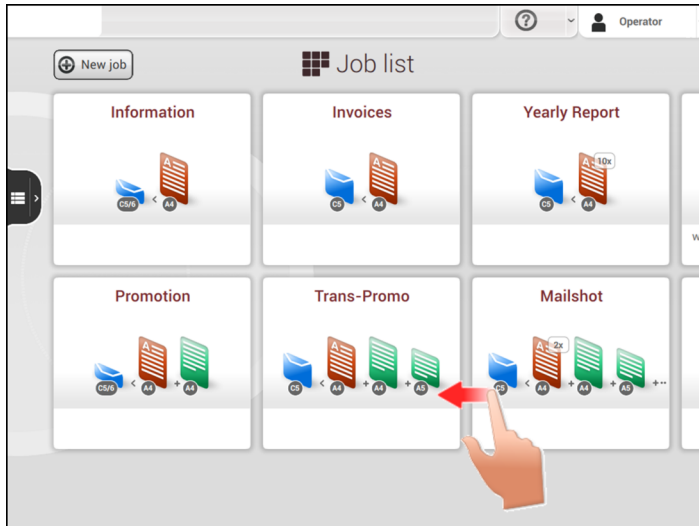

- Tap and hold: touch the screen with your finger and hold it for two seconds

2

English



2
English

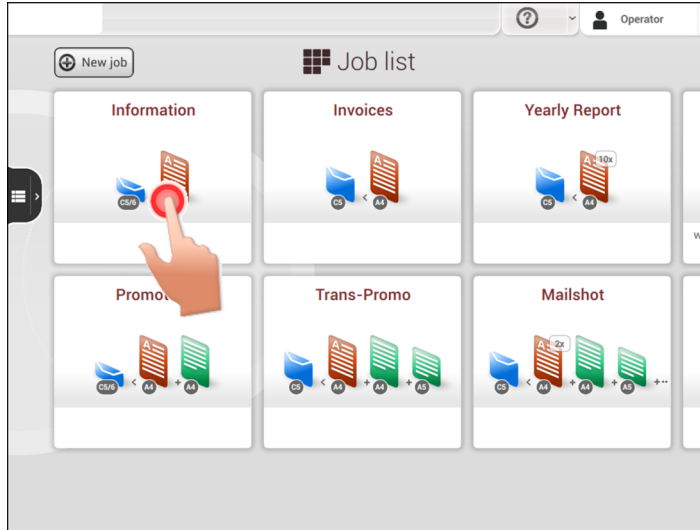

Some screens have a side menu. Which functions the side menu contains, depends on the screen you are working in, and on [authorization](#) on page 3.

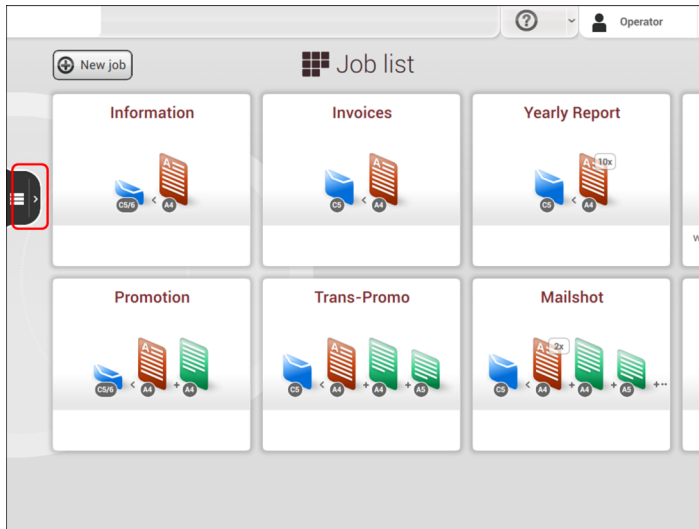

To open the side menu, tap the icon on the left.

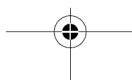

Open a Web Browser

You can open a web browser in the user interface of the system. Open the web browser as follows:

1. Tap on the logo in the upper left corner of the screen.

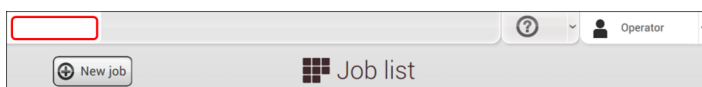

2. Tap the cross in the upper left corner of the screen to close the web browser.

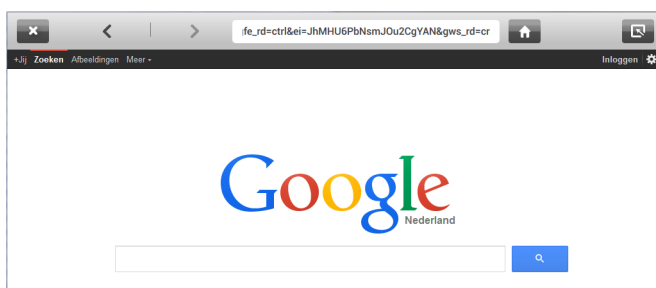

If you work with a special keyboard for your language, you can [switch the keyboard back to the English version](#) on page 82 to type e.g. a web address.

What is a Job?

If you have to process a lot of mail sets of the same type (for example bills), you can save the settings to a 'job'. The next time you just select the job and immediately start without defining any settings.

The following settings are saved in a job:

- Envelope type/size;
- Sealing on/off;
- Which document feeders should be used, how many documents should be fed from each feeder and document height for each feeder;
- Feeder linking on/off;
- If BREs or insert cards should be included;
- Address position;
- Fold settings;
- Double feed control settings;
- Reading settings (option);
- Exit select settings;
- Batch Counter, defining the number of mail sets that the job must process. The job will automatically stop processing when this number is reached.

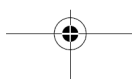

Job List

2
English

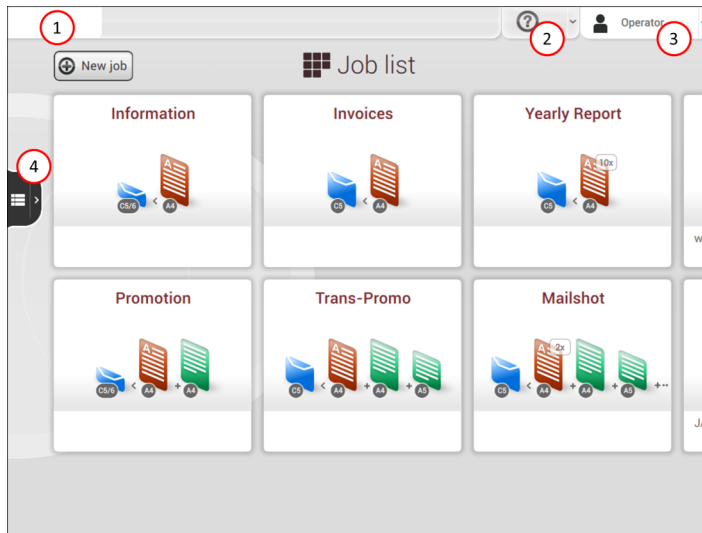

When you start up the system, the 'Job list' menu appears.

1. [Open a web browser](#) on page 11
2. [Help menu](#) on page 1
3. Login, see [Introduction](#) on page 3
4. Side menu

The side menu contains the settings menu (see [Settings menu operator](#) on page 74). When you are logged in as supervisor, the settings menu is extended with advanced settings (see [Settings menu supervisor](#) on page 76).

If you want more information on a job, select the job. With the **[Job list]** button you get back to the home menu.

See also: [Working with Jobs](#) on page 19.

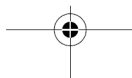

Job Overview

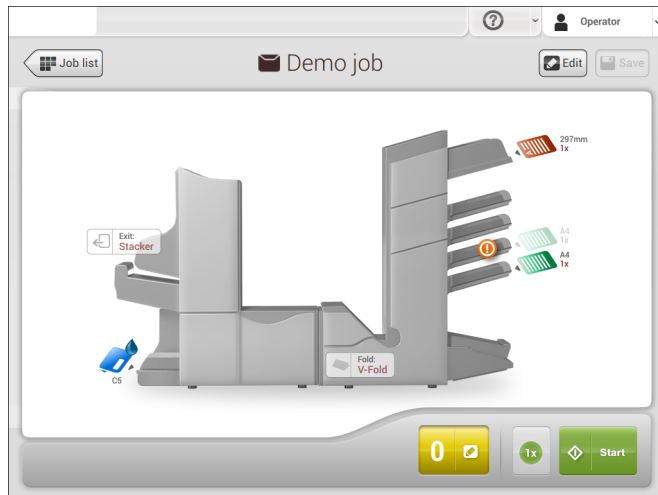

2

English

If you want more information on a job, select the job in the Job List menu.

The touch screen shows the following information of the selected job:







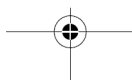







- Job name
- Job settings (for example the document and envelope type)
- How to load envelopes and documents for this job
- The number of envelopes that have been processed with this job

In this screen you can change the following settings:





- Counter settings (see [Change the counter settings](#) on page 31)
- Job settings (see [Editing a job](#) on page 48)
- Move documents between feeders (see [Change to an other feeder tray](#) on page 47)
- Link feeders (see [Link feeder trays](#) on page 47)
- Start the job or run a test run (see [Performing a test run](#))

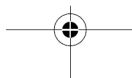

The following is a list of symbols or icons and their descriptions.

	Main document. Shows the correct document orientation; A is the address.		Document with reading Shows the correct document orientation; A is the address.
	Daily mail Feature to manually insert mail-sets one by one into the system.		Enclosure
	Notification Next to this symbol, a message appears, e.g. Sealing liquid low, empty feeder.		
	Envelope, sealing on Envelopes will be sealed. The symbol shows the correct envelope orientation.		Envelope sealing off Envelopes will not be sealed. The symbol shows the correct envelope orientation. When sealing is off, the flap of the envelope is closed but not moistened.
	Feeder linking Linking means that when one feeder is empty, the system automatically starts feeding documents from the other feeder. This symbol at the feeders shows if the feeders are linked.		Change feeder trays Possibility to change from one feeder tray to another.
	DFC/mail set thickness detection Double feed control and/or mail set thickness detection has been set to 'off'. By default the dfc/mail set thickness detection will be set to 'on' and the icon will not be shown.		Fold type This icon shows what kind of fold type has been set.
	Exit setting This icon shows what kind of exit setting has been set.		Counter setting Shows on what number the counter has been set.
	1x button After tapping this button the system will create an example mail set.		Start button Tapping this button runs the job.



	<p>Job list buttonAfter tapping this button the job list screen will be shown.</p>		<p>Stop buttonButton to stop the system The current mail set will be completed and the system stops, being empty and ready for a new set.</p>
	<p>Edit buttonGives access for editing a job.</p>		<p>Save buttonSave the job or changes that have been made to a job.</p>



English

High Capacity Document Feeder (HCDF)

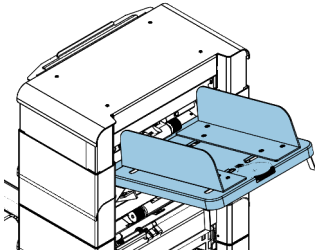

The High Capacity Document Feeder (HCDF) is an option that can be delivered from factory, or added to a 2 or 4 station version by a service engineer. The High Capacity Document Feeder has a capacity for up to 725 sheets. The normal document feeder tray has a capacity of 325 sheets.

For more information on the operation of the HCDF, refer to the topic on [loading documents for the HCDF](#) on page 63.

Production Feeder

The Production Feeder is a feeder that can be loaded with a high number of documents. This feeder is intended to be used for Business Reply Envelopes (BRE), but also 'standard' documents up to 356 mm (14") length can be processed with it.

For more information on the operation of the Production Feeder, refer to the topic on [loading documents for the Production Feeder](#) on page 59.

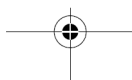

2
English

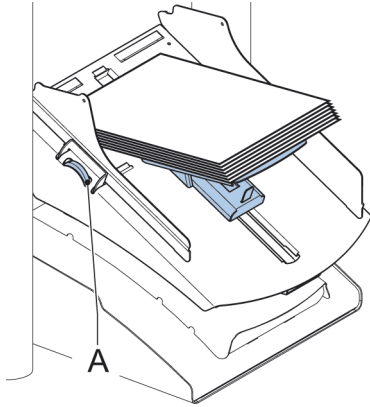

Thin Booklet Feeder (FD 6606-15)

The Thin Booklet Feeder is used to feed booklets, regardless of the thickness of the cover, to the document flow from the feeder to the inserter. Because of the location of the Thin Booklet Feeder (downstream the feeder module) documents fed by the Thin Booklet Feeder will not be folded.

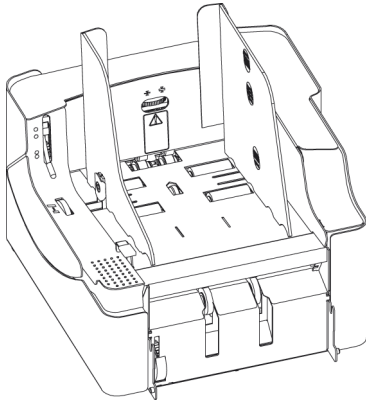

When the Thin Booklet Feeder is added to the configuration, this is shown in the screens at the operator panel.

For more information on the operation of the Thin Booklet Feeder, refer to the topic on [loading documents for the Thin Booklet Feeder](#).

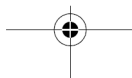

Catch Tray

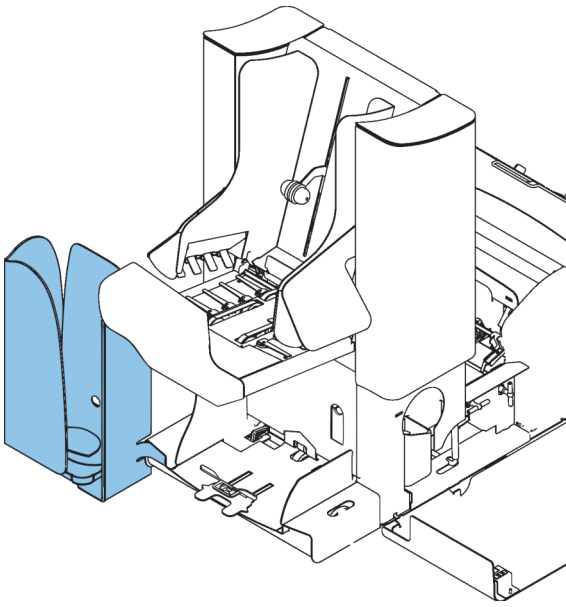

2

English

For stacking envelopes leaving from the side exit a catch tray can be mounted. You can select the catch tray in the Output settings tab of the job definition (see [Exit settings](#) on page 29).

Instead of a catch tray at the right hand (RH) side of the system it is also possible to install a catch tray on the left hand (LH) side. To achieve this it is necessary to reverse the side exit of the Stacker from RH to LH. Contact your supplier for more information about this option.

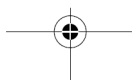

Shut Down the System

2

English

1. Press the **[On/Off]** button  next to display **B** to shut down the system.

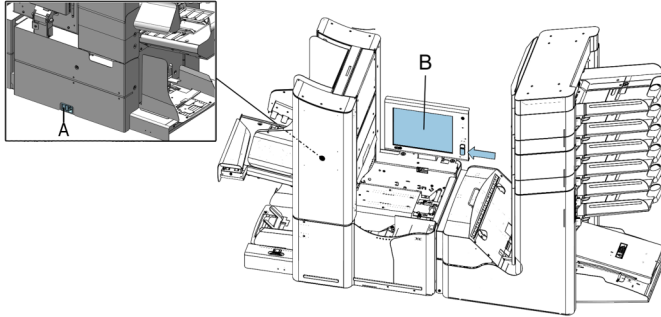

When the system is busy, it completes and inserts the current set, stops and will be shut down.

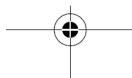

3 Working with Jobs

Introduction

With the system you can process mail sets in the following ways:

- **Using an existing job.** Existing jobs are shown in the Job list and saved via the 'automatic' or 'manual' job creation process. How to use an existing job is described in [Using an existing job](#) on page 19.
- **Automatic job:** The system automatically picks one sheet from each filled feeder and processes them into mail sets. The automatic feature is described in [About Automatic jobs](#) on page 21.
- **Manual job:** various settings, not available in an Automatic job, can be set in a 'manual job. This includes the use of daily mail. Working with manual jobs is described in [Create a manual job](#) on page 23.

3

English

Use an Existing Job

If you want to use an existing job:

1. Open the job list.
2. Tap the icon of the job you want to use.

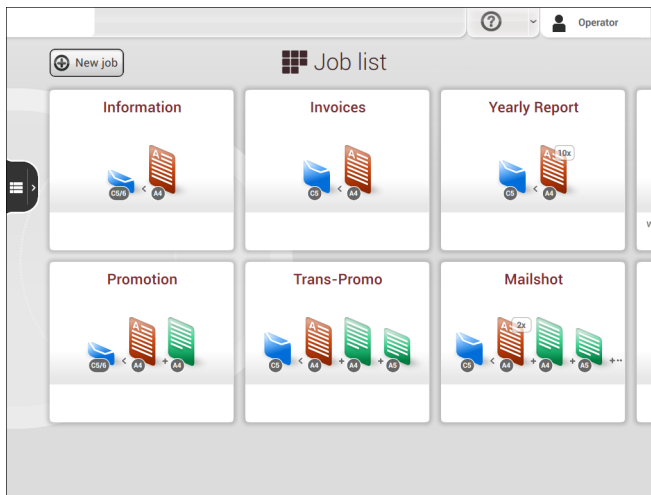

3. Load the feeders as shown on the display.
4. Tap **[1x]** to create an example mail set, see [Example mail set](#) on page 35.
5. Select an exit for the example mail set.

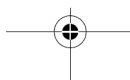

6. Check the example mail set.
7. If example mail set is OK: tap **[Start]**. If the example mail set is not OK: adjust the address position or envelope stop position or check and re-adjust the job settings.



If desired tap the counter button to set the counters. See [Counter settings](#) on page 31.

3

English

8. Tap **[Start]** to start the job.
9. Press the **[Stop]** button to finish the job.
10. Tap **[Job list]** to return to the job list.

Create a New Job

To create a new job:

1. From the Job list menu, tap **[New job]**.
2. Choose **[Automatic]** or **[Manual]** to create a new job.

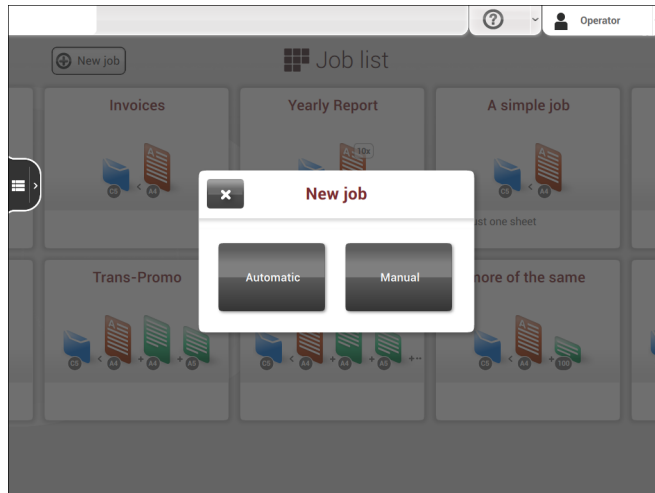

3. If you choose 'Automatic' follow the description as can be found in [Create an Automatic job](#) on page 21.
 4. If you choose 'manual' follow the description as can be found in [Create a manual job](#).
-

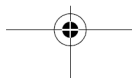

About Automatic Jobs

You can save every automatically created job and edit it like any job.

An Automatic job processes mail sets according to the following rules:

- The machine picks one sheet from each filled feeder;
- The picked documents will be folded (if necessary) and inserted into an envelope;
- Only the feeders that feed successfully will be selected;
- Only the Double Feed Control (DFC) of the upper feeder will be selected (this is done automatically).

The following features are not supported with Automatic job processing.

- Linked feeders (the option where, if one feeder is empty, the system automatically continues using another feeder)
- Multiple sheet feeding (picking more than one sheet from a certain feeder)
- Daily mail
- Reading functionality
- No envelopes (use envelopes yes/no)
- Exit select

If you want to use any of these features, you have to use Manual jobs to process the mail set.

Create an Automatic Job

Proceed as follows if you want to create an automatic job:

1. From the Job list menu, tap **[New job]**.

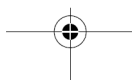

2. Tap **[Automatic]** to start an Automatic job.

3
English

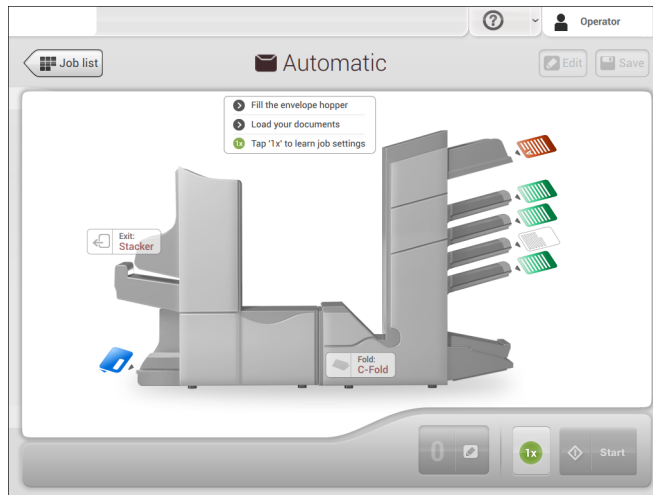

3. Fill the envelope hopper, load your documents and tap **[1x]** to create an example mail set.
4. Make sure that the address position and the envelope stop position is correct. If not, [adjust the address position](#) on page 36 and [envelope stop position](#) on page 39.
5. If necessary, tap the counter symbol to set the counters. See [counter settings](#) on page 31.
6. Tap **[Start]** to start the job.
7. Tap **[Stop]** to finish the job.

Tap **[Save]** if you want to save the settings of the Automatic job to a new job.

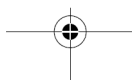

Create a Manual Job

Introduction

Creating jobs manually is easy: the user interface guides you through the job definition with clear steps.

These steps are:

- Define the mail set: envelope type, main document and optional enclosures.
- Define how to fold the document set.
- Define the exit of the system that should be used for this job.

Create a Job Manually

To create a job manually:

1. From the Job list menu, tap **[New job]**.
2. Choose **[Manual]** to define the job settings.

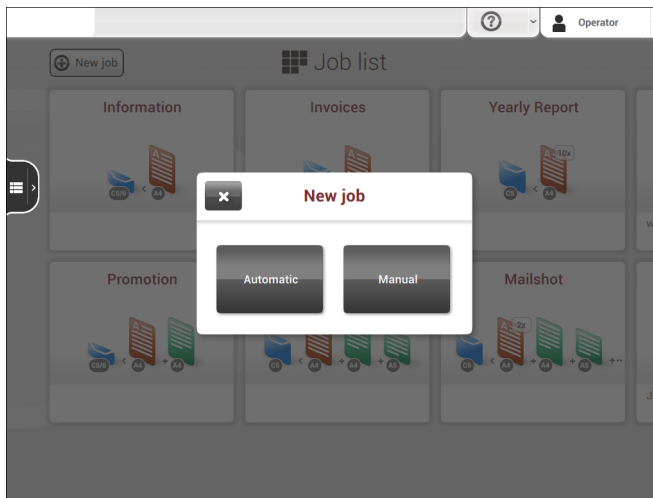

Continue with the envelope settings (see [Envelope](#) on page 24).

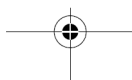

Mail Settings

Envelope

3
English

1. Tap **[Envelope]**.

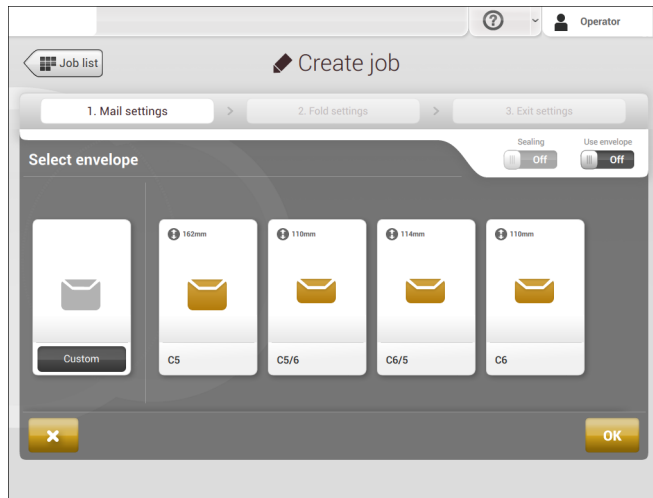

2. Select a predefined envelope or [create a custom envelope](#) on page 45. Optionally tap **[Use envelope]** to set the use of envelopes to 'off' if you want to [Create a job without the use of envelopes](#).
3. Tap **[Sealing]** to switch it on or off.



By default the envelopes will be sealed.

4. Confirm the envelope settings with **[OK]**.

Continue with the main document settings (see [Main Document](#) on page 25).

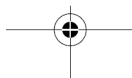

Main Document

1. Tap **[Main document]**.

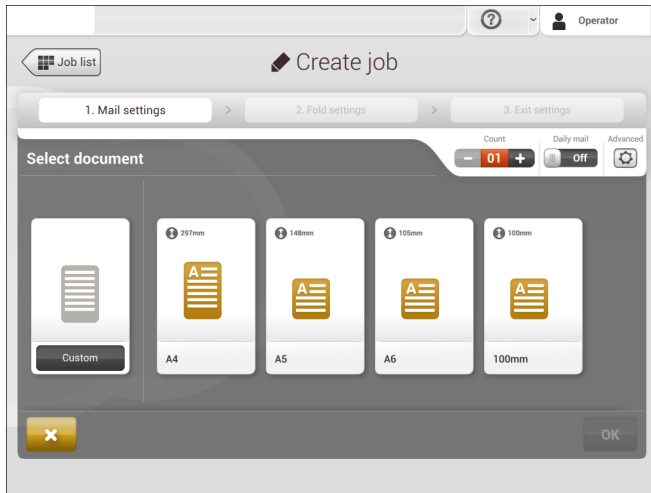

2. Select a predefined document or [create a custom document](#) on page 46.
3. Change the **[Count]** to add more than one document from a feeder (multiple sheet feeding).
4. Optionally tap [Daily Mail](#) on page 43 to set Daily Mail to 'on' or tap **[Advanced]** to set the [DFC Settings](#) on page 26.
5. Confirm the document settings with **[OK]**.

Continue with the enclosure settings (see [Enclosure](#) on page 27).



English



Switch DFC on or off for feeders

For every feeder you can switch the double feed control (DFC) on or off.
To change the DFC settings:

1. Tap the job that you want to change the DFC settings for.
2. Tap **[Edit]**.
3. Tap the document that you want to change the DFC for.
4. Tap **[Advanced]**.

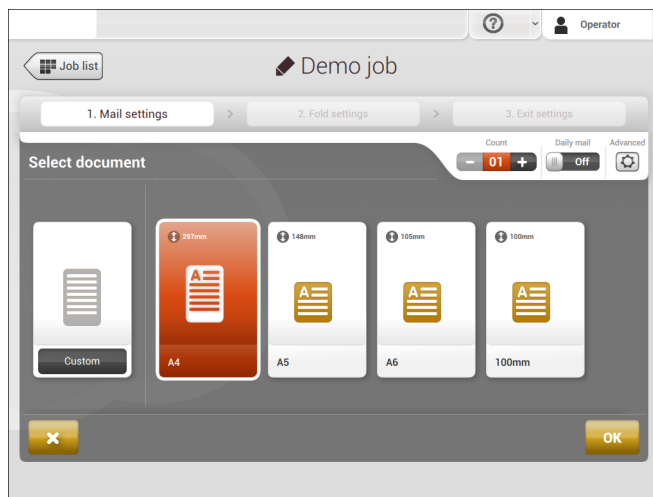

5. Tap Double Feed Control to switch it on or off.
6. Tap Continue on double to switch it on or off. If Continue on double is on, the machine will not stop if two sheets are fed instead of one. The document-set that contains the double sheets will be diverted.

English

3

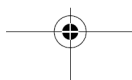

Enclosure

1. Tap **[Add enclosure]**.

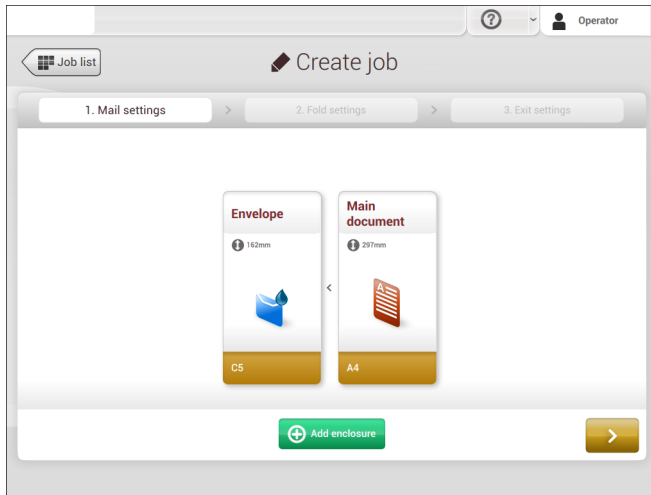

2. Select a predefined document or [create a custom document](#) on page 46 as your enclosure.

If you want to remove an enclosure from the job, or change the order of the enclosures, see [Delete or move an enclosure](#) on page 50.

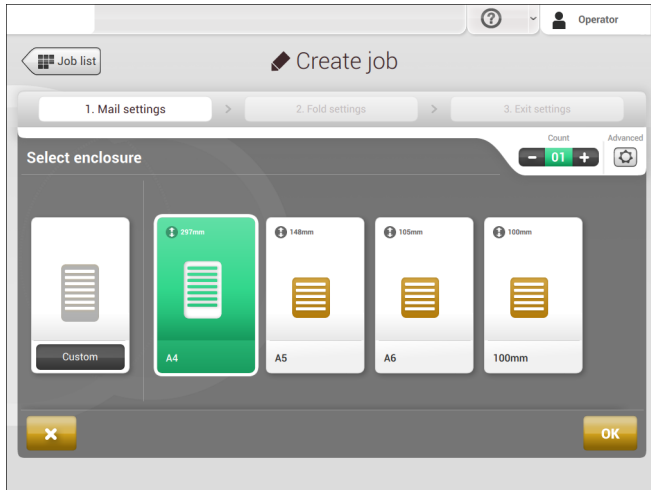

3

English



3. Change the **[Count]** for more than one document from a feeder.
4. Confirm the enclosure settings with **[OK]**.

Continue with the fold settings (see [Fold settings](#) on page 28).



English

Fold Settings

Default the machine suggests the most logical fold type. This fold type is highlighted in purple. However, you can select other fold types and change their settings.

1. Tap a fold type.

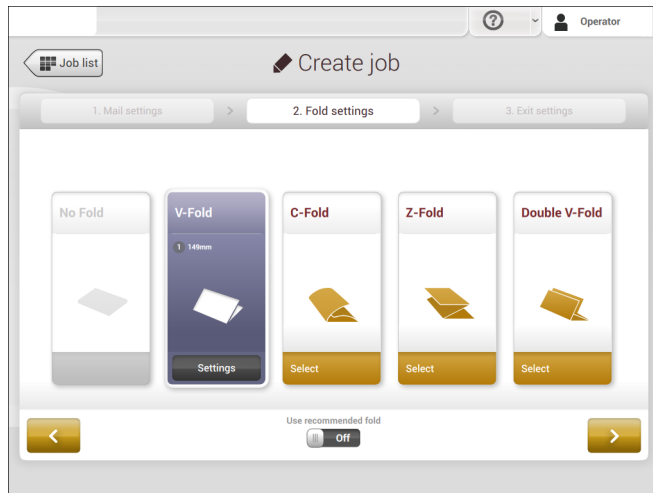

2. If necessary, tap **[Settings]** to change the fold settings.
3. Tap **[>]**.

If you want to revert to the machine recommended fold type, switch **[Use recommended fold]** to On.

Continue with the exit settings (see [Exit settings](#) on page 29).

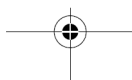

Exit Settings

1. Select the Exit Settings:

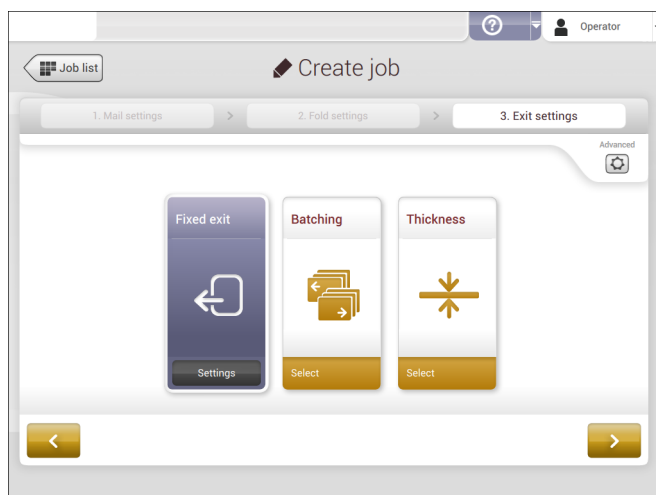

The system has two exits: the stacker and the side exit. In the Exit settings of the job, you define which exit is used. When Reading is on, [more options for exit selection are available](#) on page 122. Standard (without reading), you choose between:

- **Fixed exit:** tap **[Settings]** to select which exit must be used for this job. If you select stacker, you can choose to let the system continue on the side exit if the stacker is full.
 - **Batching:** tap **[Settings]** to define after what number of mail sets, the system must switch to the other exit.
 - **Thickness:** tap **[Settings]** to define the exit for document-sets that are too thin or too thick. At the inserter, the thickness is measured and compared to a reference thickness. Depending on the selection in this menu the envelopes exit to the stacker or the side exit. The first document-set determines the reference thickness.
2. Optionally tap the **[Advanced]** button to set the [mail set thickness detection](#) on page 30 settings.
 3. Tap **[>]**.

Continue with [Finish the job definition and start the job](#) on page 34, or set the [counter settings](#) on page 31.

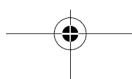

Switch the mail set thickness detection on and off

You can switch the mail set thickness detection to 'yes' (= on) or 'no' (= off). By default the mail set thickness detection is set to 'yes'.

To change these settings:

3



If the job uses reading, you cannot switch on the Mail Set Thickness Detection (DFC) for the document set. With reading, the document set size can be different for every set.

English

1. Select the job that you want the change the mail set thickness detection setting for.
2. Tap **[Edit]**.
3. Navigate to 3.Exit settings.
4. Tap **[Advanced]**.

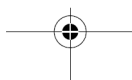
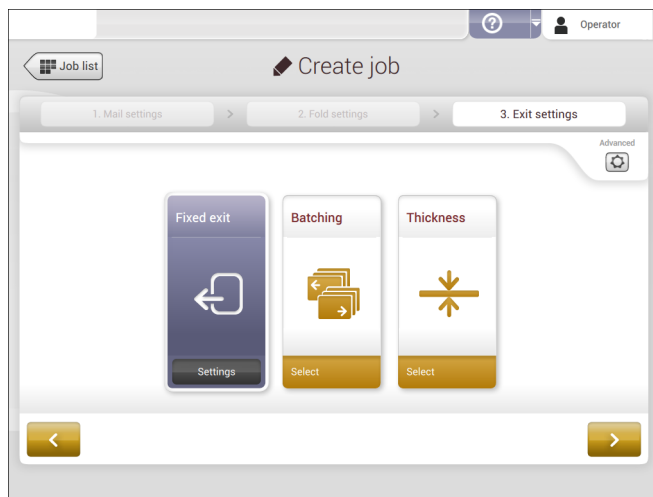

5. Tap the 'Double Feed Control' button to switch it on or off.

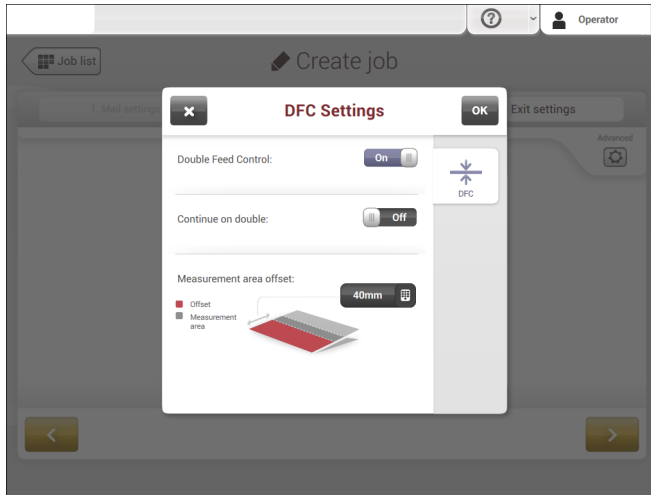

6. Tap the 'Continue on double' button to switch it on or off. If Continue on double is on, the machine will not stop if two sheets are fed instead of one. The mail set that contains the double sheets will be presented on deck.
7. Enter the 'Measurement area offset'. After the DFC detects the document set, it delays the thickness measurement. It starts measuring as soon as the offset has passed.

Change the Counter Settings



The counter settings are job related.

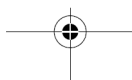



English

In the Counter submenu you can set the (daily) Job counter, the Stop counter and the Job total counter. The following will be shown in the Counter submenu:

- Job counter (as shown), the daily job counter: number of mail sets that have been processed using this job, after tapping [Start].
- Stop counter/Stop at value: set a number (of processed mail sets) after which the system stops processing. You can set from 5 through 9999. The system will continue processing mail sets until the job counter reaches the stop counter value. The system stops and can be restarted.

When the processing of mail sets has been interrupted the system shows how many mail sets have been completed. This is shown at 'completed so far'.

- Job total counter: total number of mail sets that have been processed using this job.

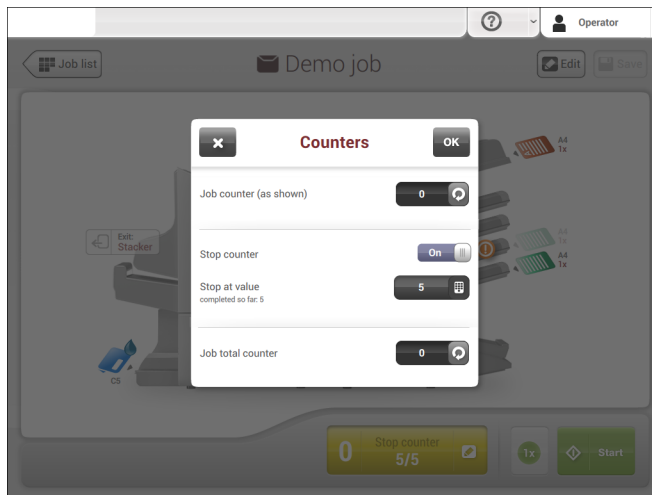

To reset/set the counters proceed as follows:

1. In the Job overview screen tap the counters button.

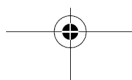

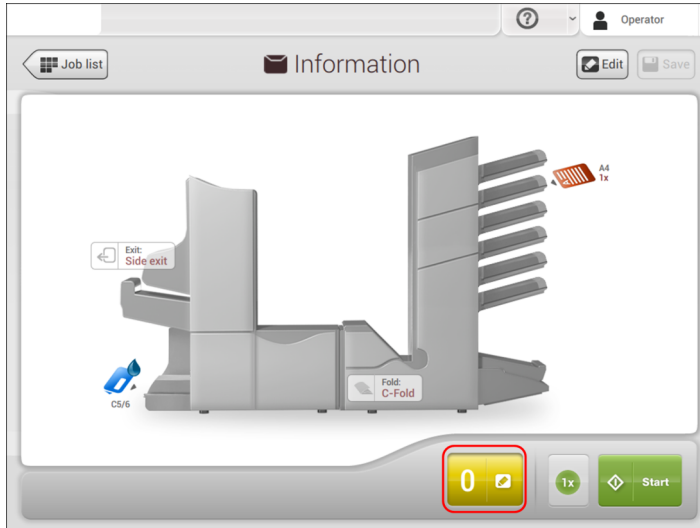

2. Tap the reset button for the daily job counter to set it to zero.
3. Tap the **[on/off]** button to set the Stop counter to 'on' or 'off'. If you set the Stop counter to 'on' you can enter the 'Stop at value'. Enter a value from 5 through 9999.
4. Tap the reset button for the Job total counter to set it to zero.



If you set the Job total counter to zero the number history of this job will be lost.

5. Tap **[OK]** to go back to the job overview screen and tap **[Start]**.



English

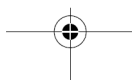

Finish the Job Definition and Start the Job

When you have finished the exit settings, the touch screen shows an overview of the job settings.

3
English



In this screen you can change the following settings:

- Move documents between feeders (see [Change to an other feeder tray](#) on page 47)
- Link feeders (see [Link feeder trays](#) on page 47)
- Change the counter settings (see [Change the counter settings](#) on page 31)

When you are ready with these settings, proceed as follows:

1. [Load the documents](#) on page 55 as indicated on the Job info screen.
 2. Tap [**1x**] to create a test mail set (see [Test mail set](#) on page 35).
 3. If desired, you can save the job (see [Save a job](#) on page 49).
 4. Tap [**Start**] to start the job.
-

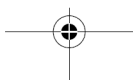

Create an Test Mail Set

Before starting an existing job or a new, manual created job, it is possible to create a test mail set.

This test run is intended to validate the settings of the Inserting System:

- Check if the address is correctly positioned behind the envelope window. See [Adjusting the Address position](#) on page 36.
- Inspect and adjust the stop position of the envelope. See [Adjusting the Envelope Insert fingers](#) on page 37.
- Check the fold settings for one set. See [Fold settings](#) on page 28.

When you tap the [1x] button, you can choose between three test mail sets:

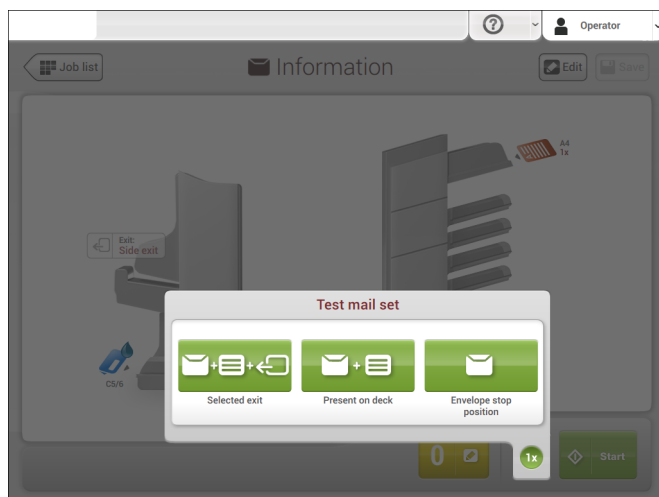

- Selected exit: creates one mail set that leaves the system at the defined exit. Use this option to test the complete process.
- Present on deck: creates one mail set without sealing. The mail set leaves the system from the upper unit. Use this option to verify and adjust the address position.
- Envelope stop position: separates one envelope and transports the envelope to the envelope stop position. Use this option to verify and adjust the envelope stop position.

After a test mail set, the system asks if the mailset is ok or not ok. When you select not ok, you are guided through a wizard that helps you to find the cause.

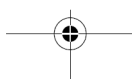

See also:

- [Adjusting the address position](#) on page 36
- [Verifying the Insert Position](#) on page 39
- [Adjusting the envelope insert fingers](#) on page 37



English

Adjust the Address Position

If the address on your mail is not correctly positioned behind the envelope window, change the address position as follows:



Adjusting the address position is only possible after creating an example mail set (by using the **[1x]** button).

1. Choose a job and tap **[1x]**.
2. Tap **Mail set not OK** if asked if the mail set is correct.
3. Tap **Address position not correct**.
4. Change the address position: slide the position indicator to the correct position.

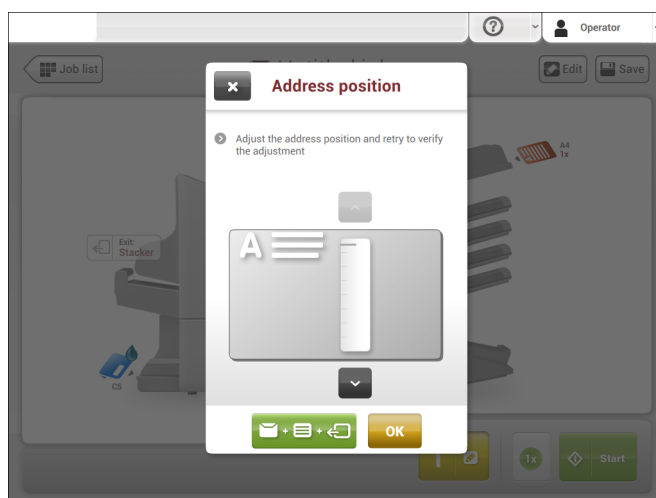

5. Tap the green button to create another example mail set or tap **[OK]** to confirm the settings.
-

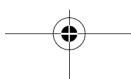

Adjust the Envelope Insert Fingers

To verify that the position of the fingers is correct:

1. Choose a job and tab [1x] (envelope only).

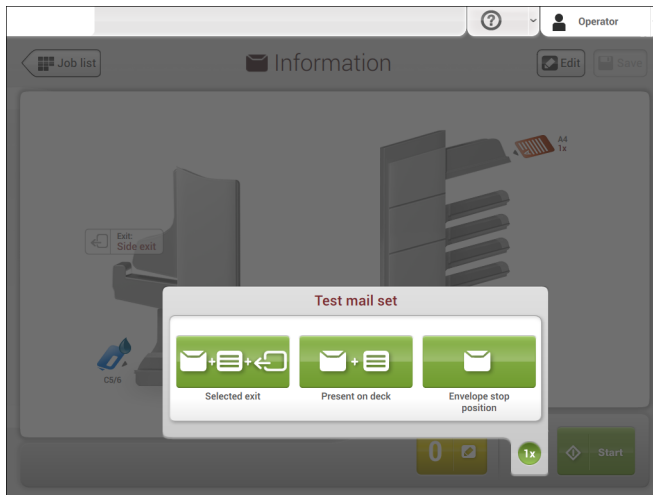

2. Tap the 'Envelope stop position' button.
3. Lift the unlocking lever A of the upper unit and pull up the upper unit.

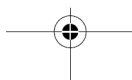
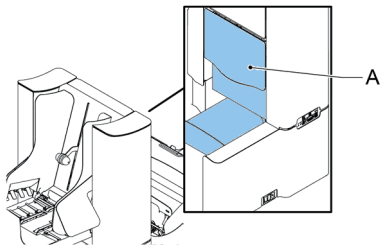

4. Tap the arrow to move to the next screen.

3
English

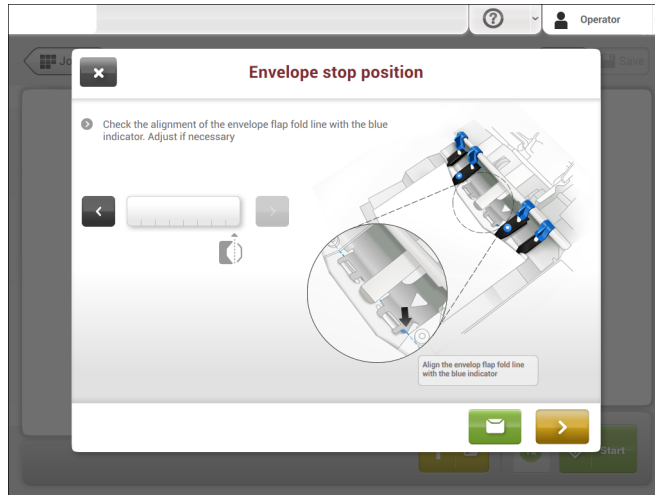

5. Follow the instructions on screen.

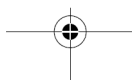
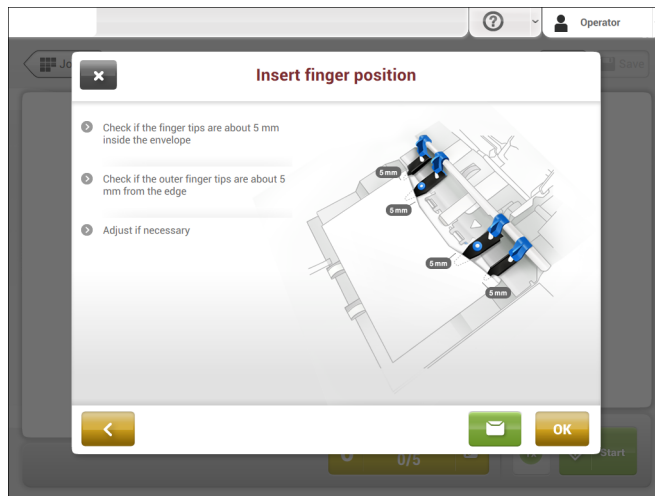

If the insert fingers are not correct, adjust the fingers as follows:

1. Loosen the knurled knob **C** on top of each finger.

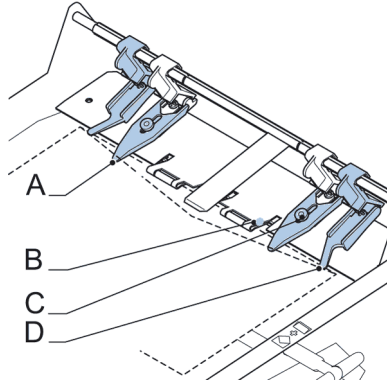

2. Adjust each finger so that the tip enters about 5 mm (0.2 inch) into the envelope.
3. Re-tighten the knurled knob. The fingers can be moved sideways to the desired position.
4. Place the outer fingers **D** about 5 to 10 mm (0.2 to 0.4 inch) from the edges of the envelope.



Check the position of the insert fingers when changing to a different type of envelope.

5. Tap the envelope button on the touch screen to fetch another envelope.
6. Make sure that the finger position is correct. If not, repeat the steps for adjusting the fingers.

Verify the Insert Position

To verify the insert position:



This adjustment must only be checked in case of problems or when changing the envelope type.

1. Choose a job and tap **[1x]** (envelope only).

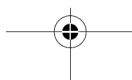

2. Lift the unlocking lever A of the upper unit and pull up the upper unit.

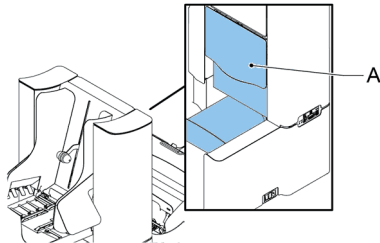

3. Follow the instructions on screen.

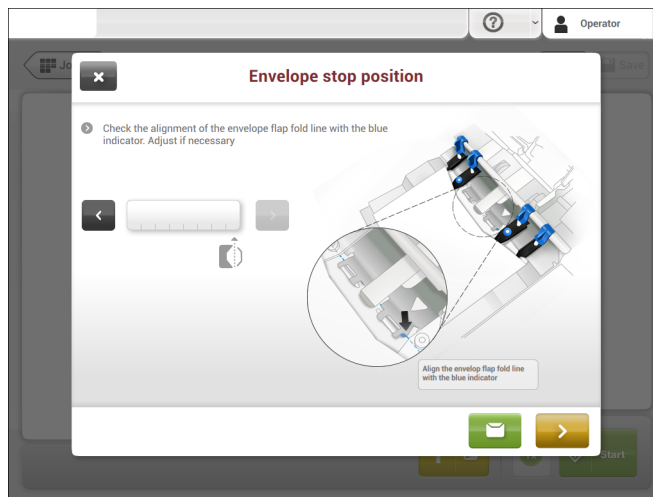

4. Tap the envelope button to fetch another envelope.
 5. Make sure that the insert position is correct. If not, repeat the steps for adjusting the insert position.
-

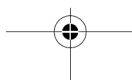

Mail Sets

Adjust the Separation of Special Feeders

Adjust the separation of special feeders as follows:

1. Push knob **A** forward until it clicks.

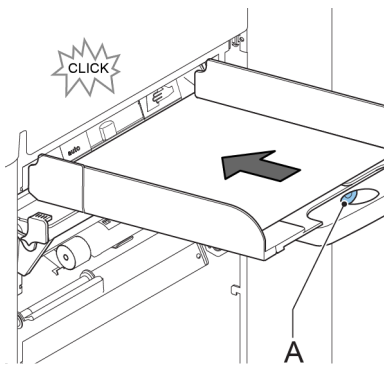

2. Turn knob **A** counter clockwise to open the separation gap.
 3. Place a document on the feeder tray and slide it into the system until it can go no further.
 4. Turn knob **A** clockwise to get resistance.
 5. Move the document to and fro. The separation is adjusted correctly when a slight resistance is felt on the document. Turn knob **A** counter clockwise again if the resistance was set too high.
 6. Pull the knob **A** back again when ready.
-

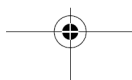

Process a Mail Set with BRE or Inserts

A mail set with BRE or insert consists of a main document (address carrier), a BRE or an insert and perhaps other enclosures. This set is inserted into an envelope.

1. From the Job list menu, tap **[New job]**.
2. Add the BRE as a (custom) enclosure.
3. Follow the job creation process (see [Create a manual job](#) on page 23).

3
English

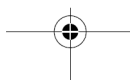
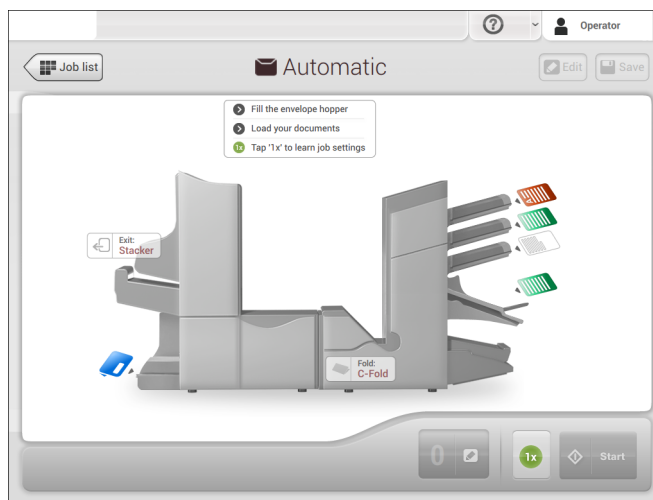

Process Mail Sets with Daily Mail

To process mail sets with Daily Mail:

1. [Create a Manual job](#) on page 23 and select **[DailyMail]** for your Main document.

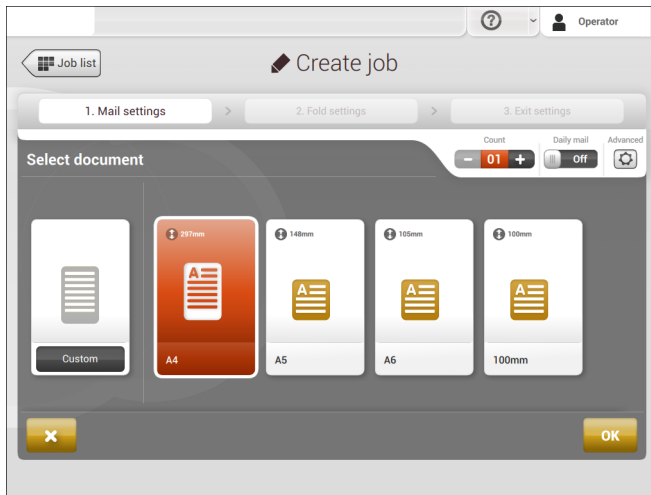

2. Complete the job settings.
3. Tap **[start]** to start the job.
A daily mail switch notification and instruction appears on the screen.
4. Turn down the left side guide **A** of the upper tray. Now you can see the Daily Mail handle **B**.

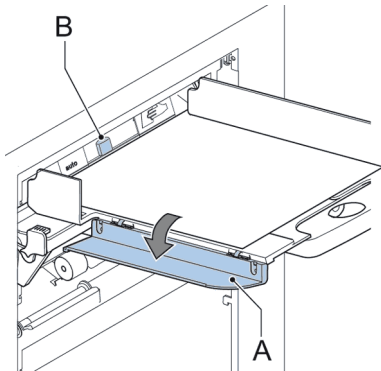

5. Move the handle **B** to the right to enable the Daily Mail function.
6. Turn side guide **A** upwards.

3

English

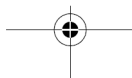



English

7. Place the document or document set in the feeder tray (see [Loading documents](#) on page 58). The document or document set will be folded and inserted into the envelope as described in the selected job.
8. Place the next document or document set in the feeder tray. The system will keep running to process the inserted document or document set.
9. When finished with Daily Mail, tap **[stop]** to stop the job.
10. Set the Daily Mail handle **B** to the 'AUTO' position to disable the Daily Mail and enable the automatic document separation.

Process Mail Sets with Very Long or Very Short Documents

When you define a job for very long or very short documents, the system asks you to adjust the document stoppers as indicated on the display.

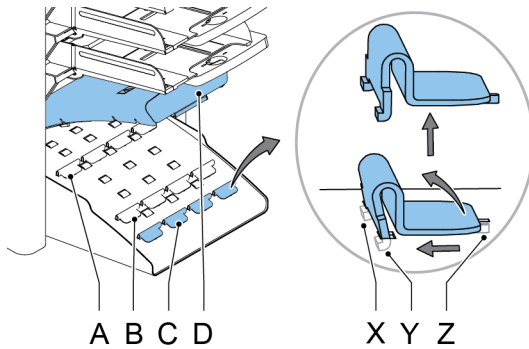

To adjust the collator stop position:

1. Lift and hold the collator arm **D**.
 2. To remove a stopper: push it towards the system to release tab **Z** from the slotted hole. Tip the stopper over and lift to release tabs **X** and **Y**.
 3. To place a stopper: insert the tabs **X** and **Y** into the slotted holes. Click tab **Z** into the slotted hole.
 4. Repeat these steps for the remaining stoppers.
 5. Close the collator.
-

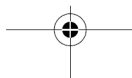

Create a Job with Custom Envelopes



Makes sure that your custom envelopes fit within the specifications (see [Envelope Specifications](#) on page 144).

3

English

1. [Create a Manual job](#) on page 23 and select envelope.
2. Tap **[Custom]**.
3. Enter the envelope height.
4. Tap the **[Flap]** tab if you use open flap envelopes.
5. Select if you want to feed envelopes with flaps up (On) or with flap down (Off).

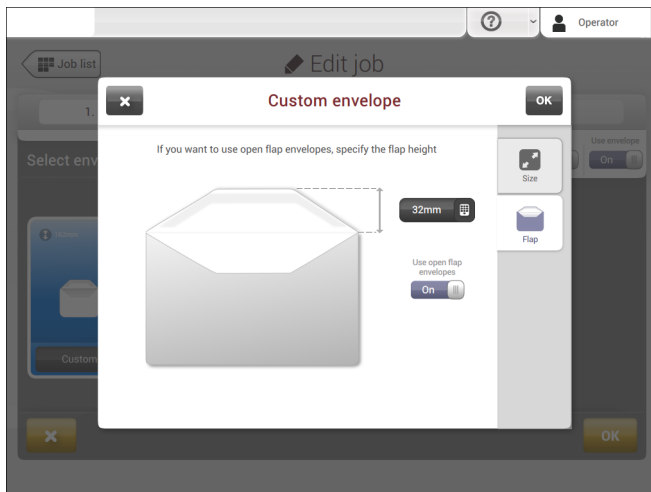

6. Tap **[OK]** to save and close the envelope settings.
7. Complete the Fold Settings and Exit Settings to complete the job and tap **[Save]** to save the job.

Follow the instructions as described in '[Create test mail set](#)' on page 35.

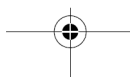

Create a Job with Custom Documents

3
English



Makes sure that your custom documents fit within the specifications (see [Document Specifications](#) on page 143).

1. [Create a Manual job](#) on page 23 and select a custom document as your main document or enclosure.
2. Tap **[Custom]** to create a custom document.
3. Enter the height of the document.

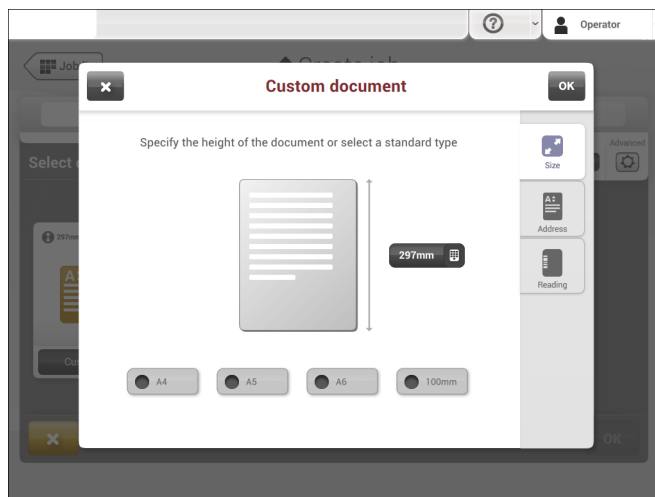

4. Tap the **[Address]** tab to set the address position for a main document.
5. Confirm the document settings with **[OK]**.
6. Complete the Fold Settings and Exit Settings to complete the job and tap **[Save]** to save the job.

Follow the instructions as described in '[Create a test mail set](#)' on page 35.

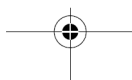

Change to Another Feeder Tray



You cannot change the order of the documents in the mail set by changing feeders. If you want to change the order of the mail set, see [Delete or move an enclosure](#) on page 50.

If you want to move the main document or enclosures to another feeder tray:

1. Select a job from the Job list.
2. Tap the document that you want to move to another feeder tray.
All available feeder trays are marked with a dotted box.

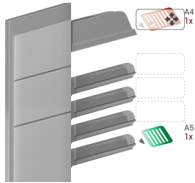

3. Tap the dotted box of the feeder tray where you want to move your document to.
The new feeder tray is selected for feeding of the document.
4. Tap **[Save]** to save the feeder tray selection to the job.

Link Feeder Trays

Link feeder trays as follows:

1. Select a job from the Job list.
2. Tap the feeder tray that you want to link to another feeder tray.
The link symbol appears.

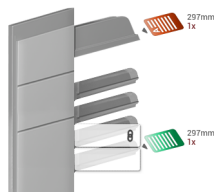

3

English

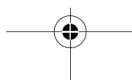

3. Tap the link symbol.

The figure shows an example of linked feeders.

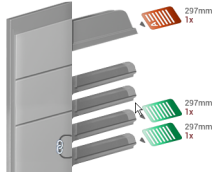

4. Tap **[Save]** to save the link to the job.

When you want to un-link the feeders, tap the feeder trays and tap the un-link symbol.

Edit a Job

To edit an existing job:

1. From the Job list menu, select a job you want to edit.



2. Tap **[Edit]**.

When you tap **[edit]**, you enter the guided job flow that enables you to make the desired changes.

3. Make the changes you want to make. When you completed the job programming, tap **[Save]** to save the changes.
4. Tap **[1x]** to make sure that the Insert Position and Address Position are correct (see [Verifying the Insert Position](#) on page 39 and [Adjusting the Address Position](#) on page 36).

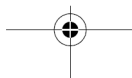

Save a Job

When you have created a new job or edited a job, save the job as follows:

1. After you have completed the job definition, tap **[Save]**.



2. Enter the job name.
3. If necessary, add a description to the job. The description is visible in the job list.
4. Tap **[OK]** to save the job.

The job is added to the job list.

3

English

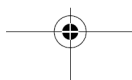

Delete or Move an Enclosure

If you want to delete an enclosure in your job or change the order of the enclosures, proceed as follows:

1. From the Job list menu, select a job you want to edit.
2. Tap **[Edit]**.
3. Tap and hold the enclosure you want to move or delete.

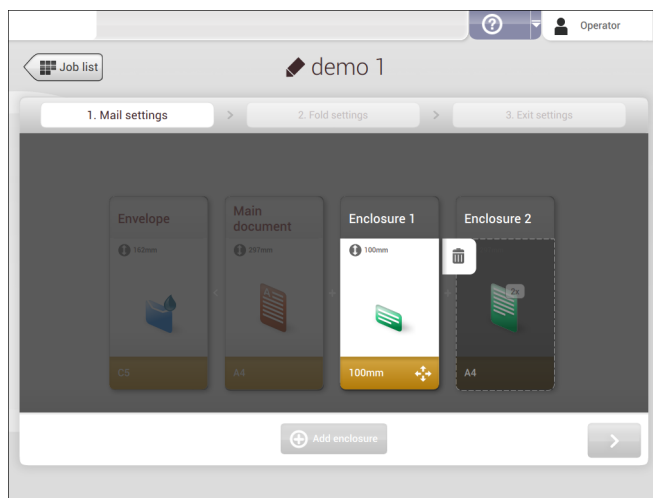

Now drag the enclosure to an other position. Or tap the waste bin to delete the enclosure from your mail set.

4. Tap the arrow buttons [**>**] to pass the other job definition steps and close the job editor.
5. Tap **[Save]** to save the changes.
6. Tap **[1x]** to make sure that the Insert Position and Address Position are correct (see [Verifying the Insert Position](#) on page 39 and [Adjusting the Address Position](#) on page 36).

3
English

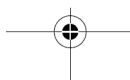

Copy a Job

To copy existing job settings to a new job:

1. Tap and hold the job in the Job list menu.

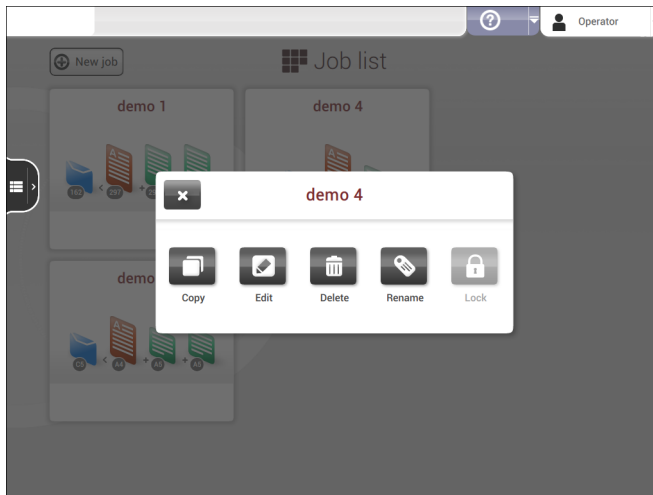

2. Tap **[Copy]**.
3. Enter the name of the new job and tap **[OK]**.

Lock a Job

To lock an existing job:

1. Log on as supervisor.

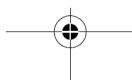

2. Tap and hold the job in the Job list menu.

3
English

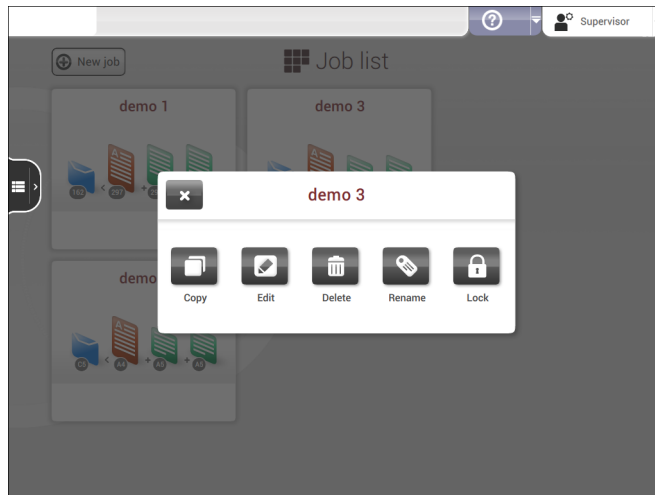

3. Tap [**Lock**].
4. Tap [**OK**] to confirm.

The job shows a lock in the job list. If the supervisor is logged on, the lock is open. If the operator is logged on, the lock is closed. The operator cannot edit, delete or rename the job.

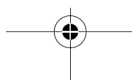

Rename a Job

To rename a job:

1. Tap and hold the job in the Job list menu.

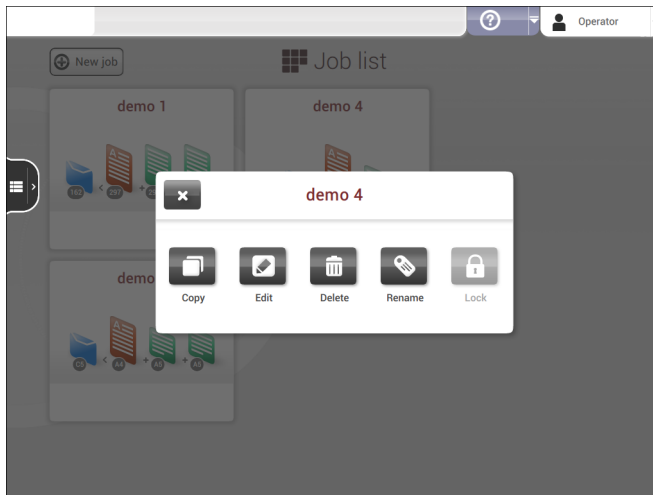

2. Tap **[Rename]**.
 3. Enter the name of the new job and tap **[OK]**.
-

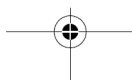

Delete a Job

To delete an existing job:

1. Tap and hold the job in the Job list menu.

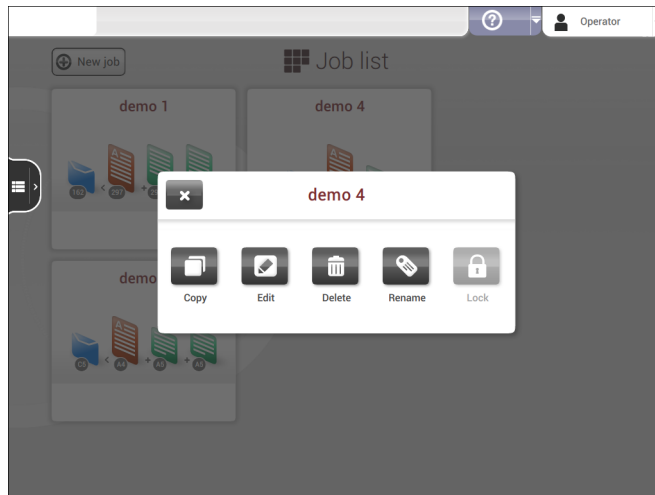

2. Tap **[Delete]**.
 3. Tap **[OK]** to confirm.
-

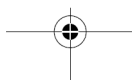

4 Loading the System

Document Orientation

The touch screen shows how to load documents and envelopes into the feeders. The table shows the meaning of the symbols:



Address carrier face up and leading (top address)



Address carrier face up and leading (bottom address)



Address carrier face down and trailing (top address)



Enclosure face up



Enclosure face down

4

English

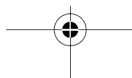

Document Feed Trays

Standard Document feed Trays

4

English

Install the Document Feed Trays

Place the document feeder trays in position:

1. Hold the document feeder tray slightly inclined as shown in the figure.

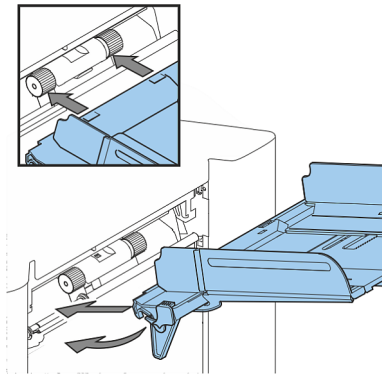

2. Place the front end of the document feeder tray underneath the two black rollers.
3. Move the document feeder tray upwards (lifting the black rollers), until it is possible to 'hook' the feeder tray into place.

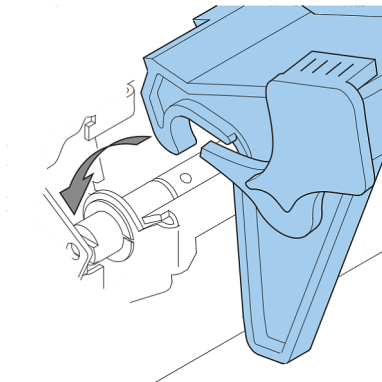

4. Move the document feeder tray towards the machine and move the hooks over the mounting points (on both sides).
5. Let the document feeder tray rest on the machine.

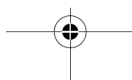

Adjust the Side Guides

To adjust the side guides it is best to remove the document feeder tray from the feeder as follows:

1. Push handle **A** downwards.

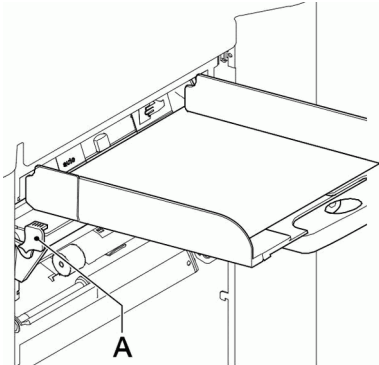

2. Lift the document feeder tray upwards to unhook it and then pull it out from the feeder.
3. Loosen the knob **B** half a turn.

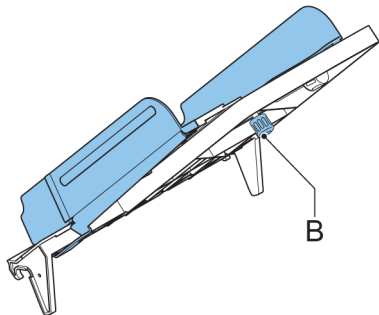

4. Grab the side guides in the middle and push them apart as far as possible.
5. Put a small stack of documents between the side guides.
6. Grab the side guides in the middle and push them towards the documents. The space between the side guides and the documents should be such that the documents have just enough play to move freely.
7. Re-tighten knob **B**.
8. Remove the stack of documents.
9. Replace the document feeder tray (see [Installing the Document Feeder Trays](#) on page 56).

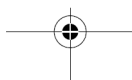

Load Documents

Fill the document feeder tray as follows:



Note the [Document Orientation](#) when filling the document feeder trays.

4

English

1. Open the left-hand side guide **A** by turning it downwards.
The feed rollers will automatically be lifted.

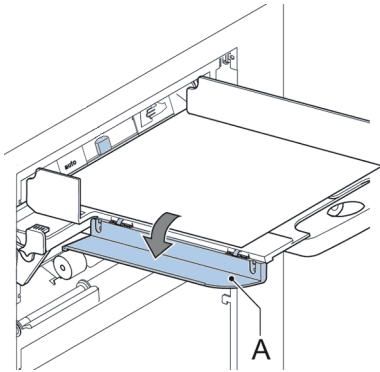

2. Place a stack of documents between the side guides.
3. Turn the left side guide upwards again.

Document Separation

The term 'Document separation' refers to the adjustment required for separating the upper document from the rest of the documents in the stack. This prevents pulling too many documents from the stack at the same time.

The document separation for the automatic feeders is set automatically; there are no manual adjustments needed.

Feeders 1 and 2 (the feeders in the two lowest positions) can be special feeders. The document separation for special feeders must be adjusted manually. While special feeder trays fit in all positions, adjusting the separation is only possible when they are fitted on position 1 and 2.

To adjust the separation of special feeders follow the instructions as described in [Processing mail sets with glossy material](#).

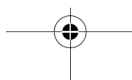

Production Feeder

Adjust the Production Feeder Side Guides

Adjust the side guides:

1. Take a stack of documents/BREs and place them in the feeder tray. BREs with flap down and leading (top side pointing to system).

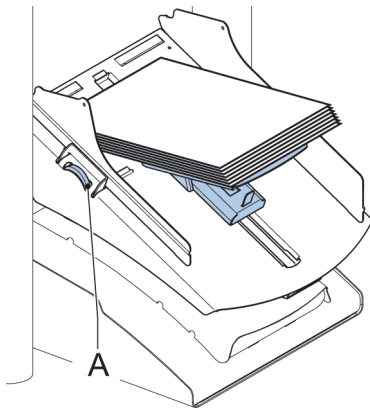

2. Adjust the side guides by turning the thumb wheel **A** such that the documents/BREs just fit and can move without resistance. Too much play causes skewing.
-

4

English

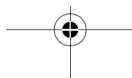

Adjust the Production Feeder Document Separation

When the Production Feeder is used at an automatic separation feeder, the separation is set automatically.

The Production Feeder can also be used on a feeder position with a manually adjusted separation. To adjust, proceed as follows:

4

English

1. Remove the document feeder trays 2 and 3.

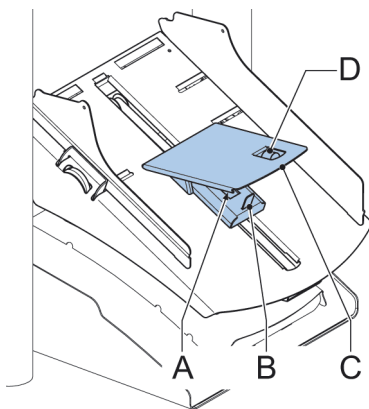

The lowest feeder is feeder 1.

2. Squeeze the two blue handles **A** and **B** and shift the feeding plate **C** as far as possible to the front.
3. Push knob **D** forward until it clicks.
4. Place a document/BRE on the feeder tray and slide it in the system till the leading edge is not visible anymore. Turn knob **D** counterclockwise if the separation is set to narrow.
5. Push the document/BRE between the rollers.
6. Turn knob **D** clockwise to get more resistance and counterclockwise if the separation is set to narrow.
The separation is adjusted correctly when a slight resistance is felt on the document/BRE.
7. Pull knob **D** back when ready.
8. Replace the document feeder trays 2 and 3.

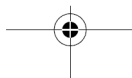

Load Documents (Production Feeder)

To load documents:



When loading the Production Feeder, make sure that the document/BREs are positioned parallel in relation to the feeding plate assembly to ensure correct feeding.

The feeding plate assembly will be shifted up automatically (when the system starts processing) until documents/BREs are underneath the rubber paper pullers.



In case of long documents, use the feeding plate extension B to support the documents.

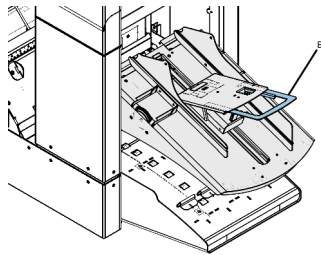

1. Squeeze the two blue handles **A** and **B**.

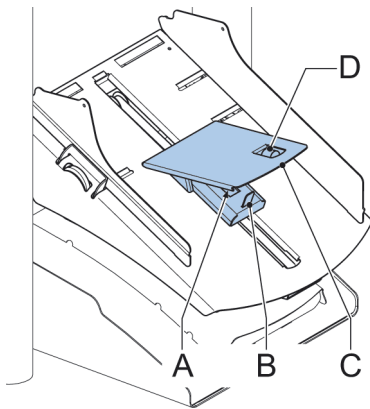

2. Shift the feeding plate assembly **C** to the rear position.
3. Loosen the stack of documents and place them in the feeder tray. BREs with flap down and leading (top side pointing to system).

4

English

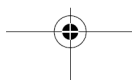

High Capacity Document Feeder

Adjust the Side Guides

4

English

To adjust the side guides **B**:

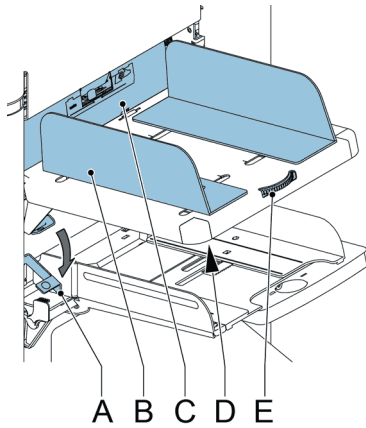

1. Loosen knob **D**, which is located underneath the feeder tray, half a turn.
 2. Put a small stack of documents between the side guides.
 3. Rotate wheel **E**.
The space between the side guides and the documents should be such that the documents have just enough play to move freely.
 4. Re-tighten knob **D**.
-

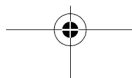

Load Documents (HCDF)

To load the document feeder tray:

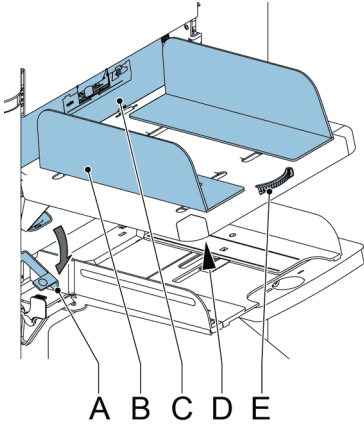

1. Pull down lever **A**.
The feeder rollers **C** move up to filling level.
 2. Place a stack of documents between the side guides (max. 725 sheets, 80 g/m²).
See [Document Orientation](#) how to place the documents in the feeder tray.
 3. Release lever **A**.
-

4

English

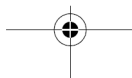

Thin Booklet Feeder (FD 6606-15)

Adjust the Side Guides

4

English

The side guides can be adjusted as follows:

1. Place a stack of documents into the feeder tray.

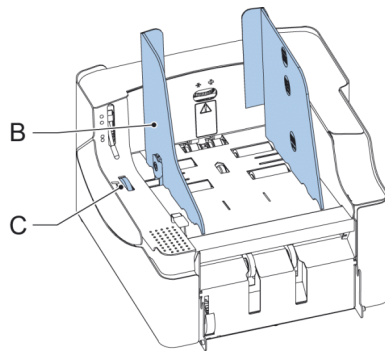

2. Adjust the feeder tray side guides **B** by turning the thumbwheel **C**. Provide just enough space for the documents to move freely. Too much play causes skewing.
-

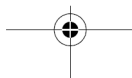

Adjust the Document Separation

The document separation can be adjusted as follows:

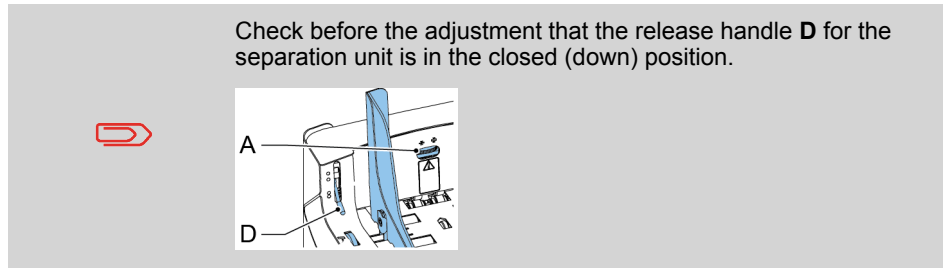

1. Turn the separation adjustment wheel **A** counter clockwise until a document can be moved backwards and forwards without resistance.

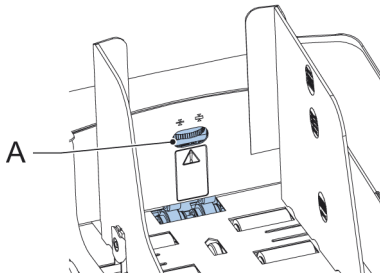

2. Turn the separation adjustment wheel clockwise until a slight resistance is felt on the document when the document is moved backwards and forwards.
3. Turn the separation adjustment wheel clockwise to get more resistance or counter clockwise to lower the resistance.
4. Check the separation before starting the system. After starting the system it may occur that more than one document at a time is pulled in. If this happens, turn the separation adjustment wheel more clockwise to obtain correct operation. For poor feeding turn the separation adjustment wheel counter clockwise.

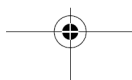

4

English



Feeder Tray Capacity

To avoid irregular feeding there are three levels for the maximum heights of the feeder tray capacity. The symbols for these three levels are printed on the right hand side guide of the feeder tray. The level indication is a guideline.

	Maximum feeder tray capacity of booklets with a tough cover (maximum height: 250 mm).
	Maximum feeder tray capacity for booklets with a weak cover (maximum height: 150 mm).
	Maximum feeder tray capacity for single sheets: minimum sheet quality: 80 gr/m2 (maximum height: 50 mm).

Load Envelopes

Before you load the envelopes, make sure the envelope separation and side guides are correctly set as described in [Adjusting the Side Guides and Envelope Separation](#) on page 67.

1. Loosen the stack of envelopes and place the stack on top of the bottom envelope.
2. Shift the envelope support in or out. The top side of the envelope must touch the dotted line on the support.

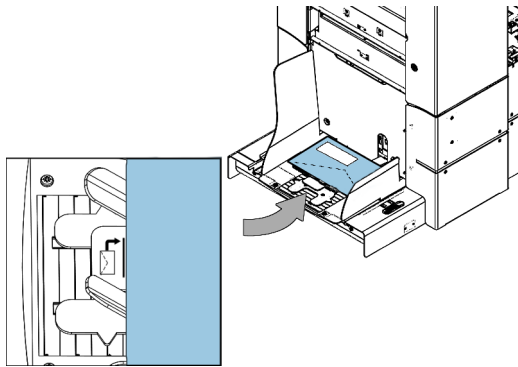

3. Turn the envelope support to distribute the weight of the envelopes evenly on both sides.

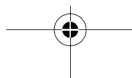

Adjust the Side Guides and Envelope Separation

Adjust the side guides and envelope separation as follows.

1. Rotate thumb wheel **D** to move the side guides **C** apart.

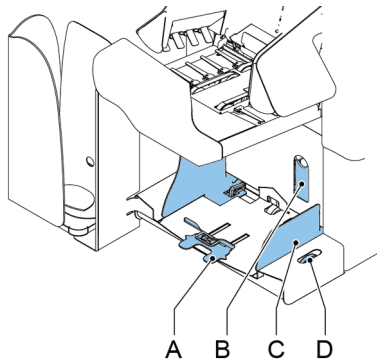

2. Put a small stack of envelopes between the side guides.
3. Move the side guides towards the envelopes. The space between the side guides and the envelopes should be such that the envelopes have just enough play to move freely.



If the distance between the side guides is too large, the envelopes will twist sideways, when transported into the machine.

4. Pull down small lever **B** to set the separation.
5. Insert one envelope up to the stoppers. The position of the envelope is flap down and trailing (bottom side of the envelope pointing to the system).
6. Return lever **B**.

4

English

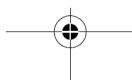

Fill the Sealing Liquid Reservoir

1. Open the front cover **A**.

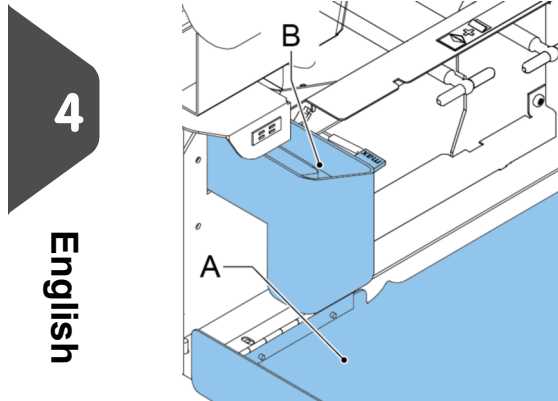

2. Fill the reservoir **B** to the "Max" lip with sealing liquid.
3. Close the front cover **A**.

Before starting the job, wait approximately 5 minutes for the brushes to moisten or use moistened brushes. For instructions on the installation of brushes, see [Clean and replace brushes](#).

If the liquid reservoir is almost empty the touch screen shows a message to warn you that you should refill the reservoir.

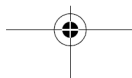

5 Options

Support for Curved Reply Envelopes (option for Thin Booklet Feeder)

Depending on the quality of the paper, the conditions during storage, etc. envelopes can be curved. This can cause smaller reply envelopes to skew while being processed by the Thin Booklet Feeder.

A special support is available to allow curved envelopes to be correctly processed. It can be used for envelopes with a height up to 110 mm (4.33").

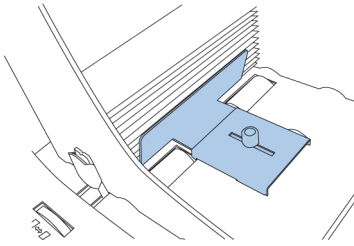

Power Stacker Support

Depending on the inserted type and amount of documents, the filled envelopes may get stack fanshaped at the stacker.

To prevent this, an optional power stacker support can be used in order to stack the envelopes correctly.

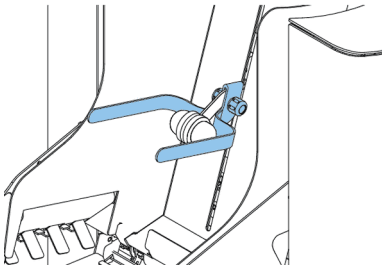

5

English

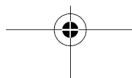

High Capacity Envelope Hopper (FD 6606-30/EF-4)

For feeding large amounts of envelopes a high capacity envelope hopper can be installed.
To start up the high capacity envelope hopper:

1. Switch on the hopper.

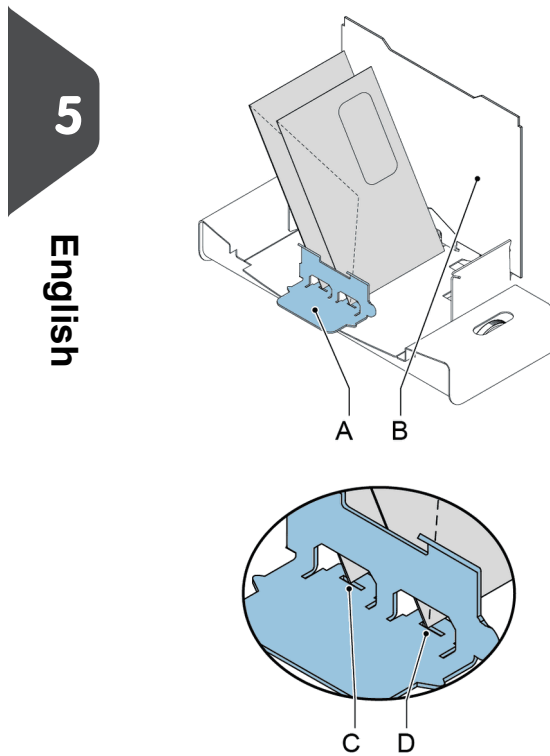

To ensure correct feeding envelope support **A** has to be adjusted parallel. Proceed as follows:

2. Move the high capacity envelope hopper backwards, away from the inserter.
3. Hold an envelope against the hopper plate **B** as indicated.
4. Place the envelope support **A** such that the envelope is aligned with recess **C**.
5. Apply the same alignment at the position of recess **D**.
6. Adjust the inserter side guides and the separation as described in [Loading Envelopes](#).
7. Put an envelope in the envelope height measurement area.

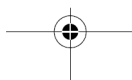

8. Rotate thumbwheel **E** to adjust the envelope height setting. The envelope should fit exactly in the space indicated by the arrows.

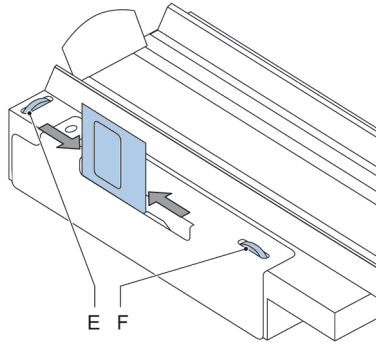

9. Rotate thumbwheel **F** to adjust the side guides so, that the envelopes:- Fit exactly between the side guides- Can move freely
10. Fill the envelope hopper with envelopes, positioned upside down. The flaps should face the inserter.
11. Tip over the envelopes.
12. Load the envelope feeder of the inserter with about 50 envelopes.

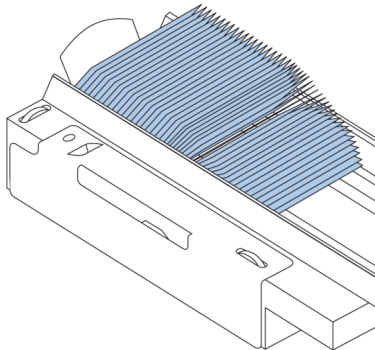

13. Press the [Start] button.

The envelopes on the envelope hopper will be transported towards the feeder of the inserter. Envelopes will be transported and dropped in the inserter feeder until the envelopes reach a certain level. At that moment a sensor will detect the envelopes and the high capacity envelope hopper will stop transporting.

When the sensor does not detect envelopes anymore the hopper will start again and the process will be repeated.

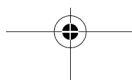

High Capacity Conveyor Belt (FD 6606-25/CS-2)

The high capacity conveyor belt is designed for envelope transport from the inserter or franking device. The conveyor belt has two operation modes:

- The belt moves continuously.
- The belt moves in intervals. The belt moves about 45 mm (1.7 inch) each time a sensor detects the passage of an envelope.

The guide plate and side guides prevent the envelopes from falling off the belt.



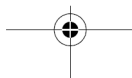
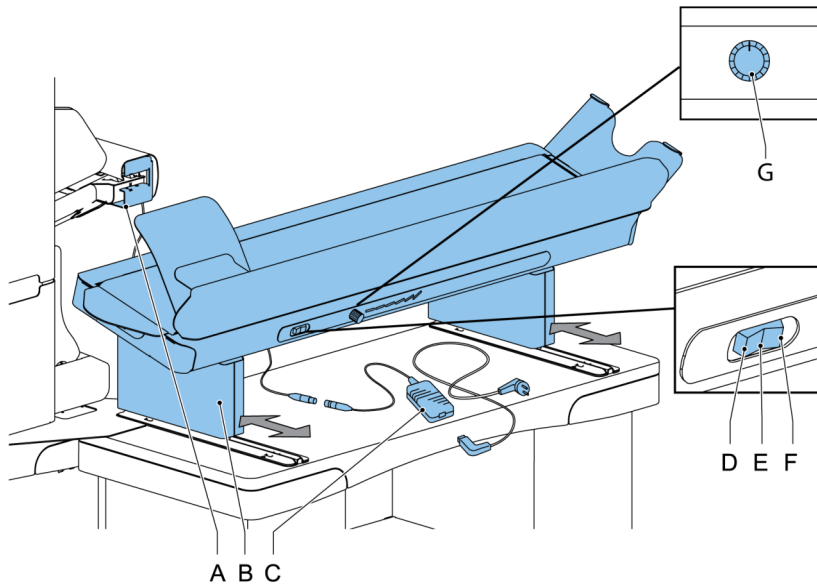

The conveyor belt switch has three positions:

- Mode **D**: the belt moves in intervals.
- Mode **E**: the belt is switched off.
- Mode **F**: the belt moves continuously.

5
English



With the turning knob **(G)** it is possible to set the interval distance between envelopes on the conveyor belt. The distance depends on the type of job and preference of the user.

(G)	Guideline:
	Minimal interval distance: 15 mm, setting for a job with thin envelopes. 
	Neutral interval distance: 20 mm
	Maximal interval distance: 40 mm, setting for a job with thick envelopes. 

5

English

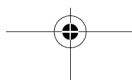

6 Settings menu

Open the Settings Menu

In the settings menu for the operator it is possible to edit the display settings and to set the localisation.

If you want to view or edit any of the Operator Settings:

1. Go to the Job list and tap the side menu on the left side and select **[Settings]**.

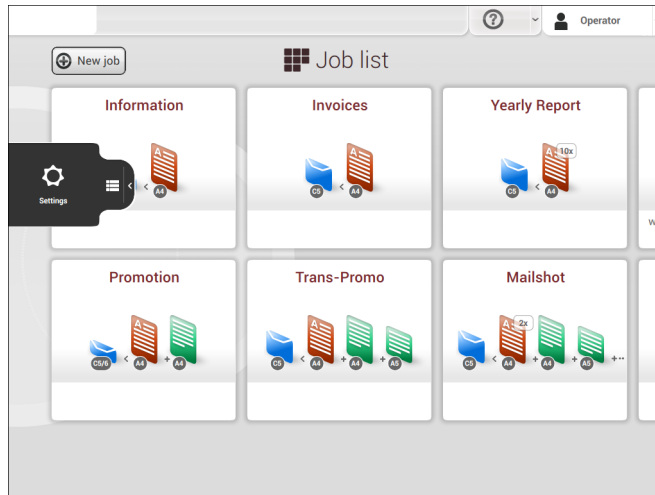

2. Tap **[Localisation]** if you want to change the document standard or the language.

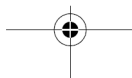
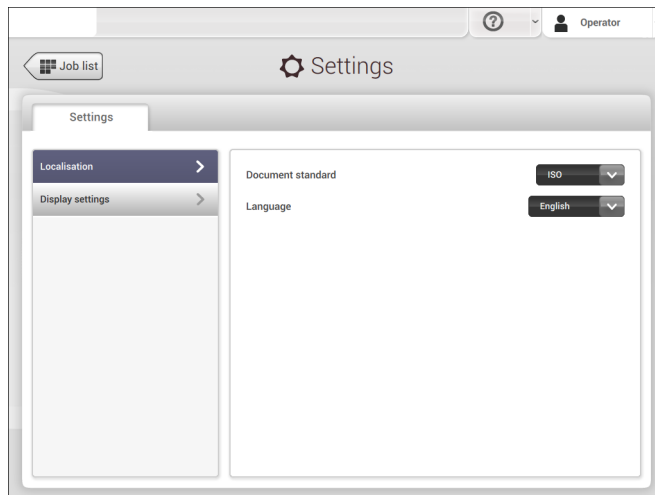

3. Tap **[Display settings]** if you want to:- set the 'Key' click to on/off
 - set the Volume
 - set the Backlight
 - set the Brightness To set the backlight and brightness, a test pattern is available as a reference.

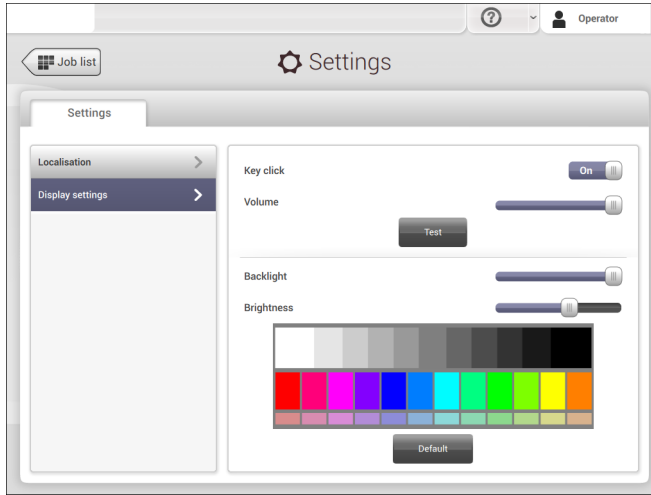

For more information on Open source licenses, see [Open source licenses](#) on page 88.

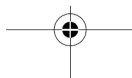

Open the Settings Menu (Supervisor)

Supervisor Settings are all settings that can be found under the Settings Menu when logged in as supervisor (pin code 2546).
The following flowchart shows which subjects are available via the Supervisor settings menu.

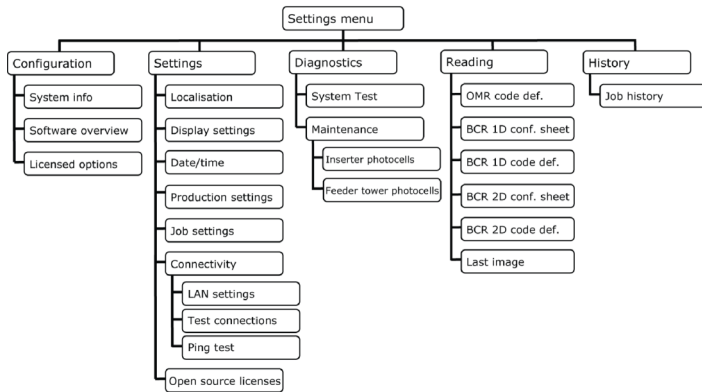

6
English

If you want to view or edit any of the Supervisor Settings:

1. Login as Supervisor with pin code **2546**.

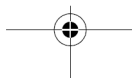
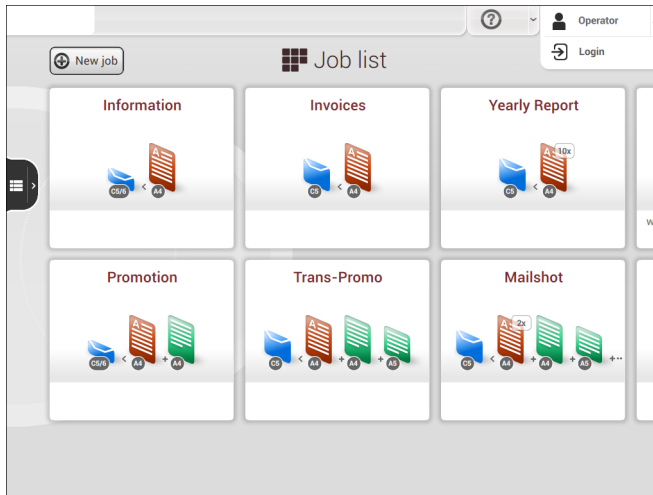

2. Go to the Job list and tap the side menu on the left side and select **[Settings]**.

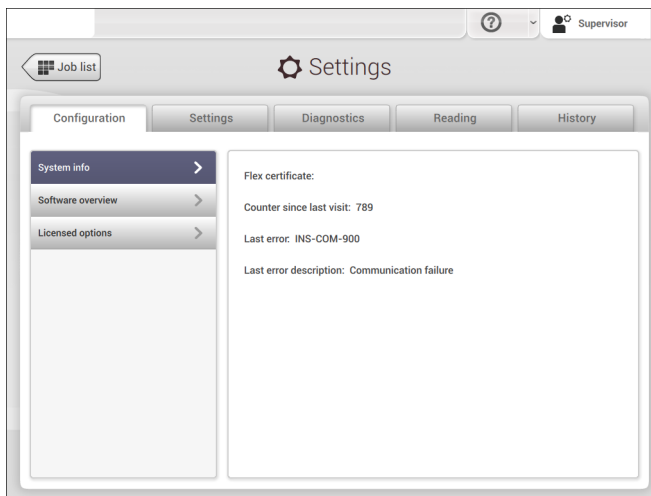
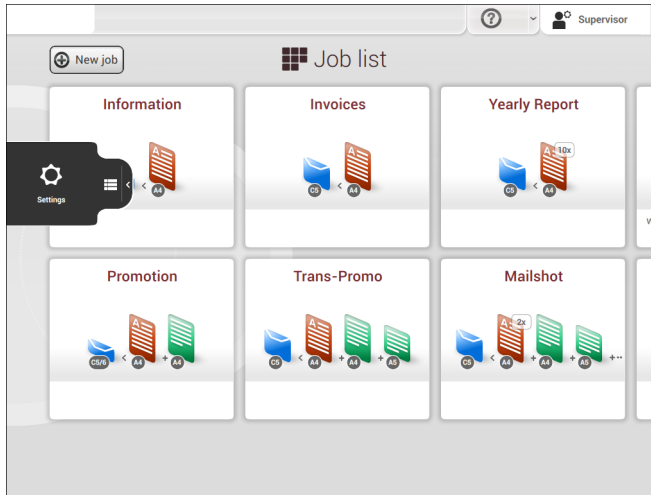

English

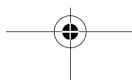

Supervisor Settings Menu

Configuration

The Configuration menu contains the configuration information settings for the system.

System Info

The System info part of the Configuration menu shows the following information:

- Flex certificate - this option is used for reading
- Counter since last visit - the counter value since the last service visit
- Last error (description) - The last error and error description generated by the system



English

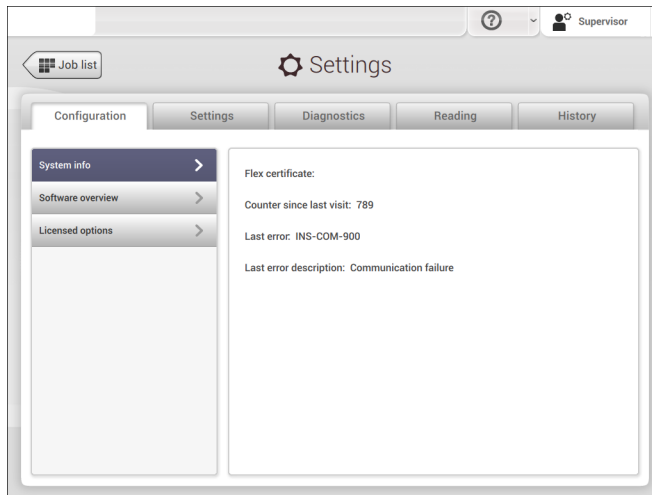

Software Overview

The Software overview part of the Configuration menu shows the versions of the software that is present in the total system.

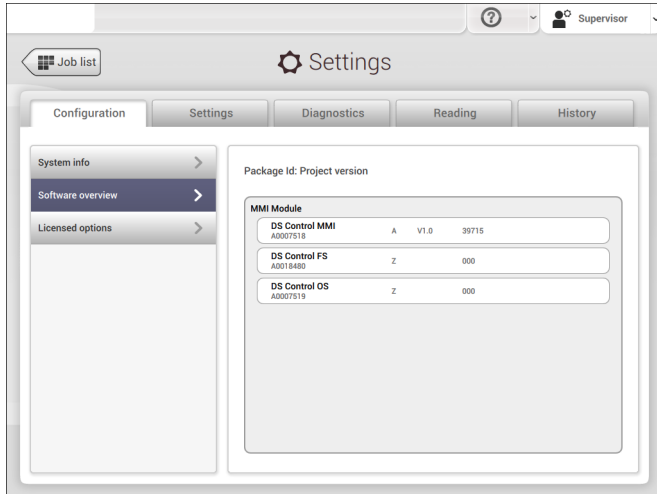

English

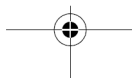

Licensed Options

The Licensed options part of the Configuration menu shows the following information:

- Chip ID
- Serial number
- Installed options

The installed options are enabled with license codes. These license codes, together with the identification number of the machine enable the relevant options. The enabled and available software options are displayed in this screen. Contact your dealer for information about these license codes.

The system supports the following licensed options:

- Remote assistance
- Online help
- Advanced/Basic reading
- OMR 1 track
- BCR 1D
- BCR 2D
- OCR
- Flex reading

6
English

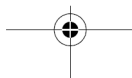
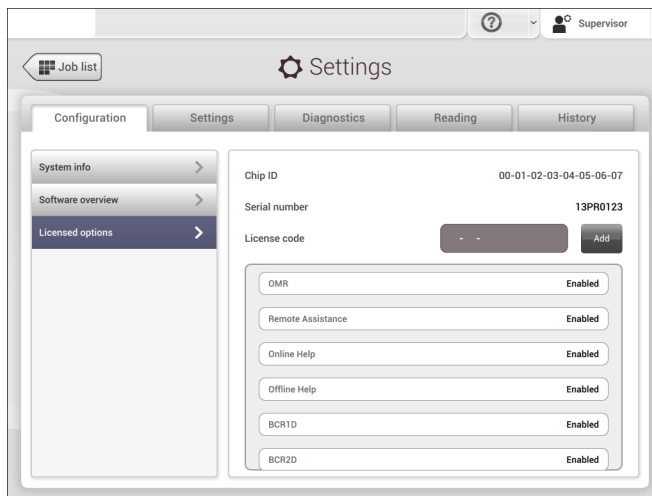

Add a Licensed Option

To add a licensed option:

1. In the Configuration, Licensed options screen, enter the license code.

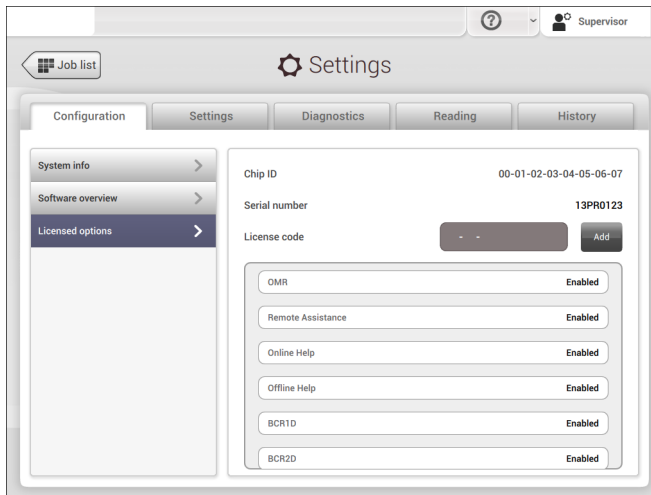

2. Tap **[Add]**. The system verifies the license key.

If the license key has been verified successfully, the option is added to the system and can be used.

Settings

The Settings menu contains the configuration settings for the system.



Localisation

Tap **[Localisation]** if you want to change the document standard or the language.

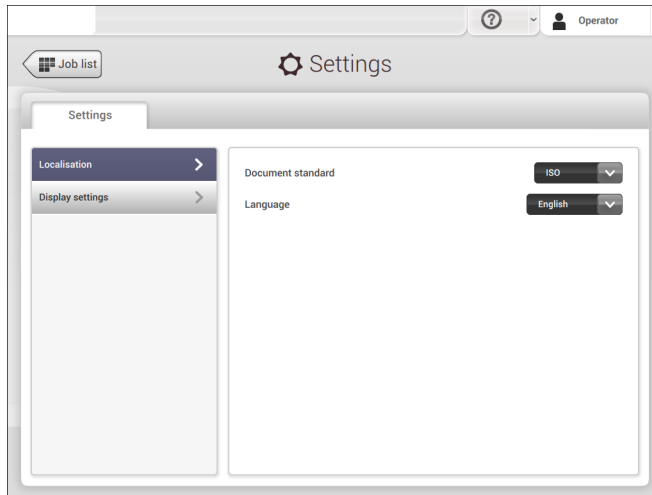

English

When you need a keyboard to enter e.g. a job name, you get a special keyboard in case of Russian, Czech and Katakana. But the keyboard has always a button to switch back to the English keyboard.

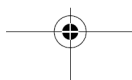
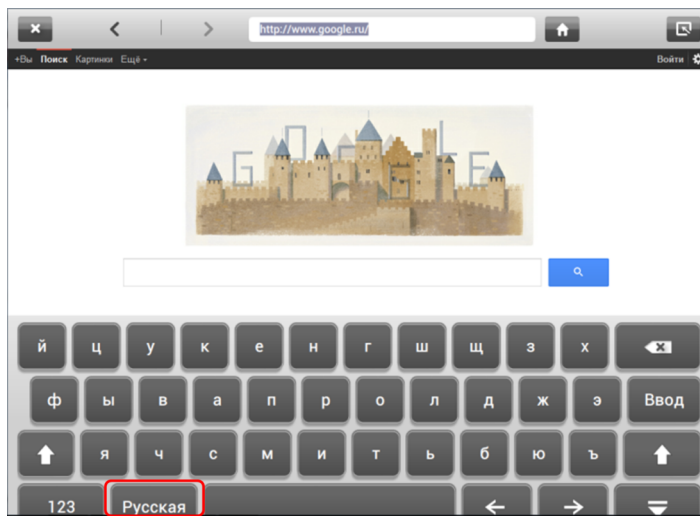

Display Settings

See [the settings menu for the operator](#) on page 74.

Date-time

Tap **[Date/time]** to set the:

- Date
- Time
- Date format; you can choose between three format to show the date: dd-mm-yyyy, mm-dd-yyyy or yyyy-mm-dd
- Time format; you can choose between a '12 hours' notation or a '24 hours' notation

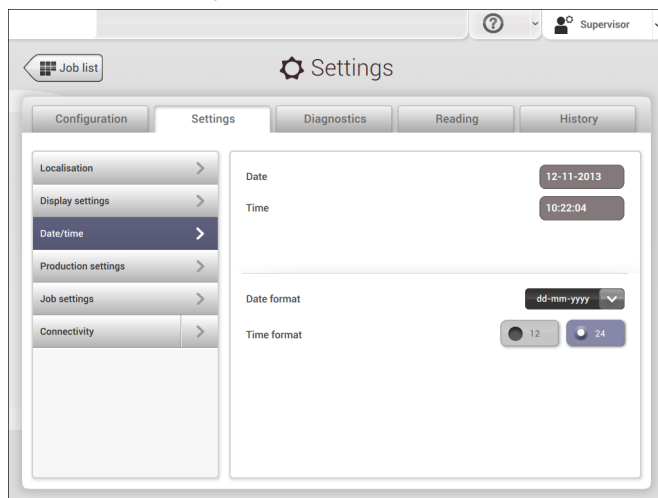

6

English

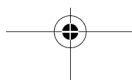

Production Settings

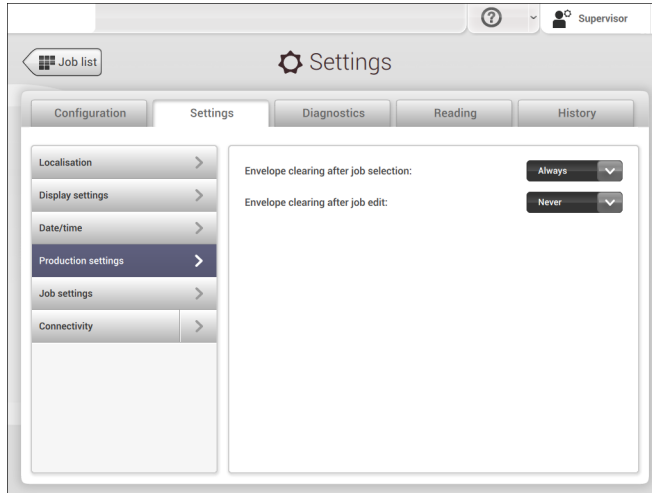

6

English

Tap [**Production settings**] to define when envelopes should be cleared from the system.

- Envelopes clearing after job selection: this setting defines if the envelopes should be cleared when you select a job. 'Ask' means that the system asks if you want to clear the envelopes.
- Envelopes clearing after job edit: this setting defines if the envelopes should be cleared when you have edited a job. 'Ask' means that the system asks if you want to clear the envelopes.

Job Settings



Job settings normally will be changed by a service engineer only. Therefore first consult the service organization before you change any settings. Changes to the job settings can result in malfunctioning of jobs.



You can also define the job settings per job. Select a job from the Job list, tap Edit, navigate to the Exit settings, and tap [Advanced](#) on page 30.

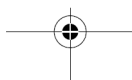

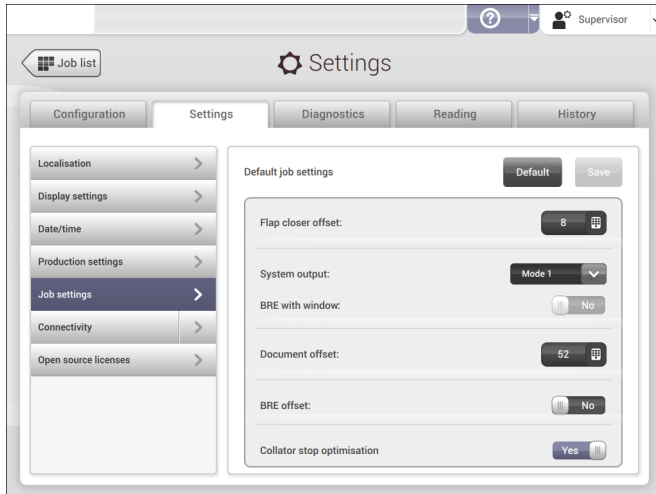

The Job settings part of the Settings menu covers settings that improve the processing of jobs:

- **Flap closer offset:** to improve the sealing of specific envelopes you can delay or advance the moment of sealing. You enter the number of pulses. A minus value means the sealing is advanced, a plus value means the sealing is delayed. You can enter a number between -20 and 20.

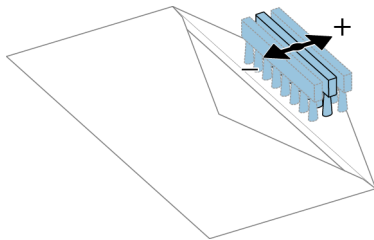

- **System output:** mode 1 mode 2
Mode 1 focuses on the versatility of paper parameters (paper thickness; document length), i.e. correct operation under even extreme paper conditions. Mode 2 is the default mode, and focuses on high speed. Use Mode 1 with a paper thickness of 65 g/m² or less, a document length of 12 inch (305 mm) or higher, and for situations where Mode 2 is not functioning properly. In all other cases use Mode 2.
- **BRE with window:** if the BRE has a window, set this setting to yes. Only available with Mode 2.
- **Document offset (A in the figure):** the extend to which documents are not overlapping in the vertical transport. In the vertical transport of documents fed by the various feeders, the documents are partially overlapping each other. This to make sure that the documents are properly aligned in the collator area. The default value is 50 mm (2.0 inch). The document offset can be varied between 20 mm (0.8 inch) and 250 mm (9.8 inch).

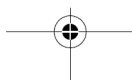

6
English

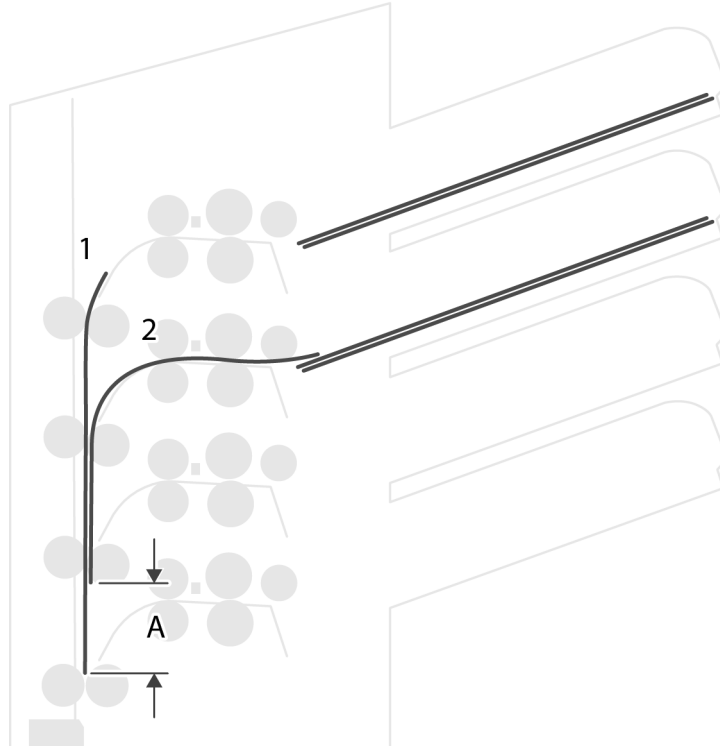

- **BRE offset:** in the case of offset is "yes", the last document that was added to the set is shifted from the rest of the set (offsetting, see below).
- **Collator stop optimisation:** if set to "off", the system does not show a message, when a collator stop change can improve the system output.

Explanation of BRE offset: if a BRE is longer than the set fold but shorter than the envelope height, this BRE can get folded (A in the figure). Under certain conditions (see below) you can prevent the BRE from being folded. In the case of offset "yes", the BRE is held back during a certain distance (B in the figure). This means that the trailing edge of the BRE leaves the collator last. The document is not folded. During the insertion into the envelope the documents of the set are aligned.

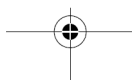
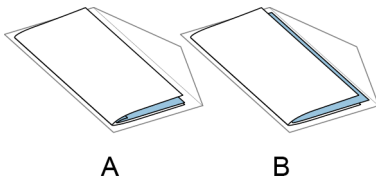

The conditions are:

- No multi-feed is used for the BREs.
- The document directly under the BRE must have a height of at least 60 mm (2.4 inch) more than the BRE.
- The height of the BRE is more than the set fold length.
- The folding mode is either V-fold or C-fold (no Z-fold).
- The BRE must be shorter than the envelope height.

The whole BRE offset is based on friction between documents within a set. Therefore it is necessary to make use of these conditions to reduce the risk of bad transporting, folding and inserting.



It is possible to use the BRE offset for a BRE and an enclosure (card) in one set. The extra condition is that this enclosure is equal to or smaller than the set address fold and should be placed direct underneath the BRE in the set.

6

English

Connectivity

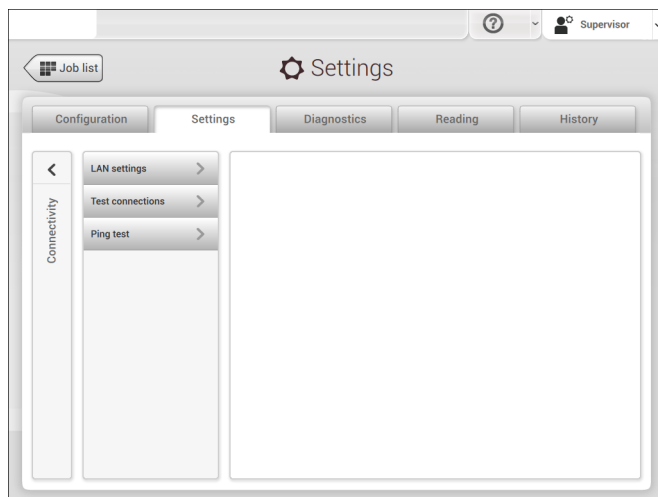

See [Connect the system to the internet](#) on page 95.

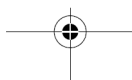

Open Source Licenses



English

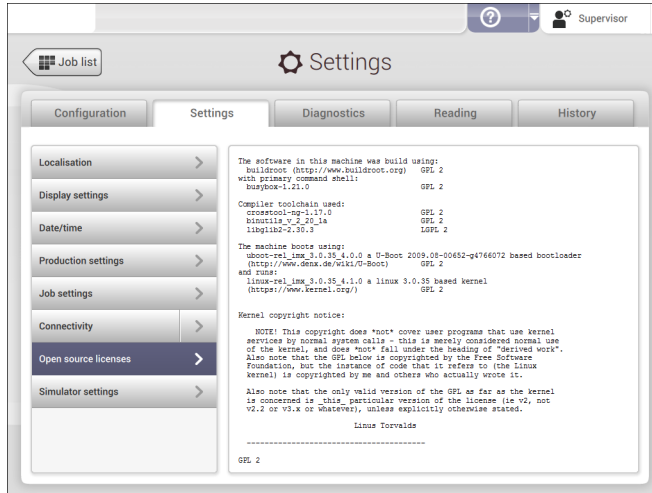

Open source licenses show license information on the open source software that is used in the system.

Diagnostics

The diagnostics menu contains the basic diagnostics functions available for a supervisor.

System Test

Use the **[System test]** to check if all motors, clutches and sensors are correctly connected. The test briefly activates the actuators and clutches and measures the current.

To run a system test:

1. In the Settings menu, tap the **[Diagnostics]** tab.

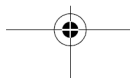

2. Tap **[System test]**.

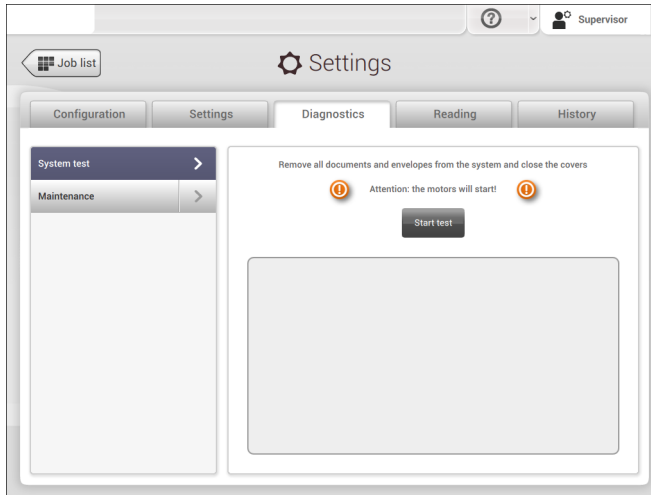

3. Remove all documents and envelopes and close all covers before starting the diagnose.
4. Tap **[Start test]**.
5. When the test is finished, the Status report is shown, showing a list of all problems found during diagnostics. If tests fail, contact your service organization.

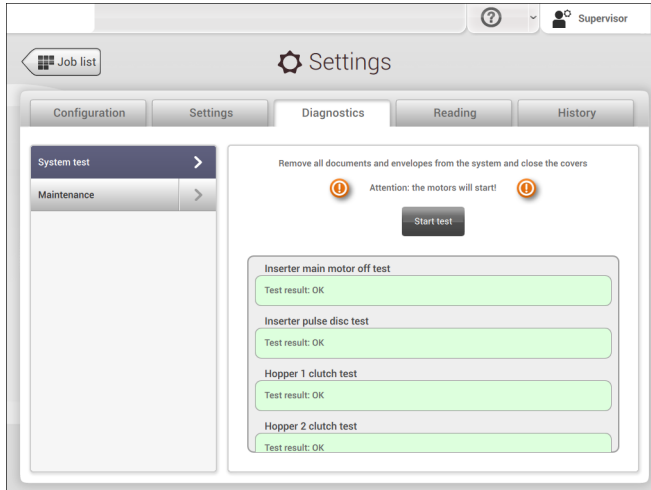

English



Maintenance

When too much paper dust is built up at the sensors a warning message will be displayed. To check the conditions of the photocells or to calibrate them follow the instructions as described in [Calibrate photocells](#) on page 126.

Reading

The reading menu contains the configuration items for the reading functions. Because reading is optional, this menu is only available when there is at least one reading license present. For more information on the reading option, see [Reading](#) on page 100.

OMR Code Definition

6
English

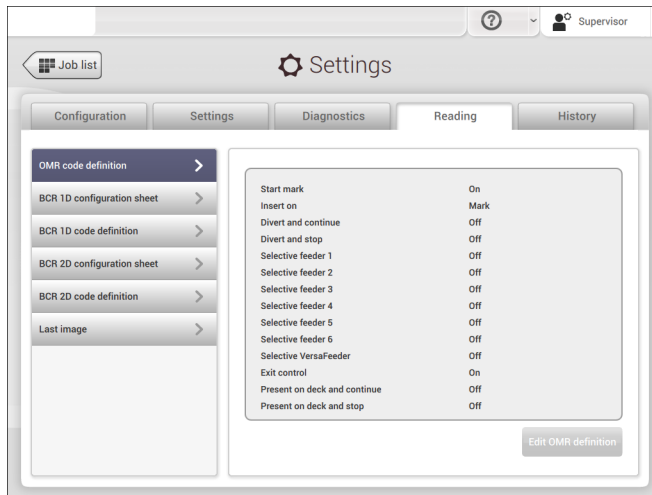

The Reading OMR code definition screen shows the configuration of the system for OMR. For every OMR code option, it shows if it is on or off. If it is on, the screen shows information on what the system does, when it reads a mark or no mark.

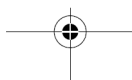

BCR 1D Configuration Sheet

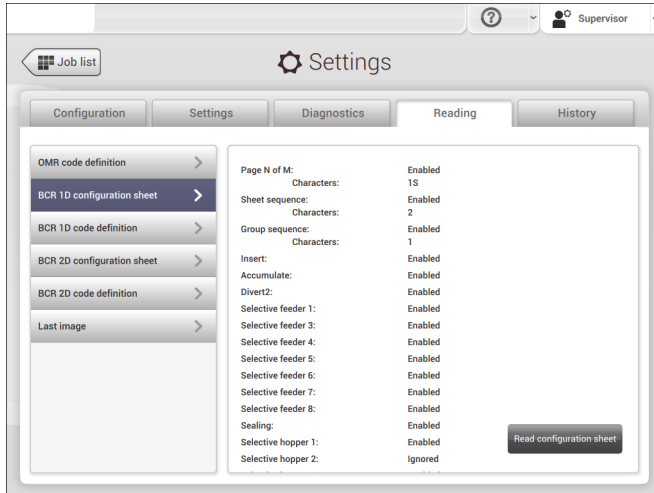

The Reading BCR 1D configuration sheet allows you to read a configuration sheet. The result is visible in this screen, but also in the BCR 1D code definition screen. See [Reading a configuration sheet](#) on page 115.

BCR 1D Code Definition

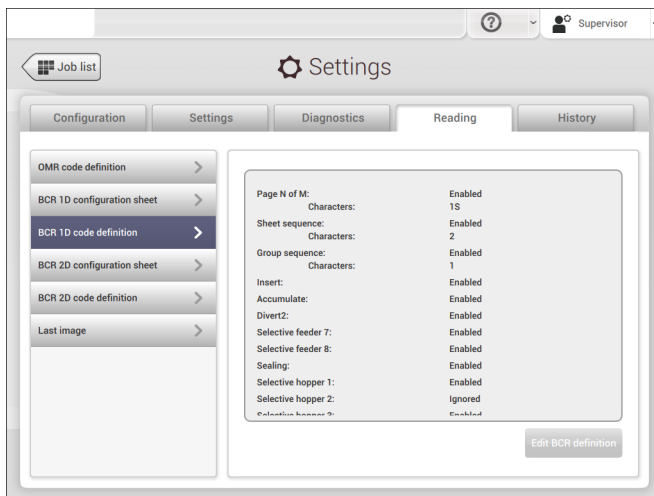

The BCR 1D code definition screen shows only information when a configuration sheet is read. It shows which codes are enabled and how they work.

6

English

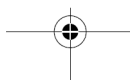

BCR 2D Configuration Sheet

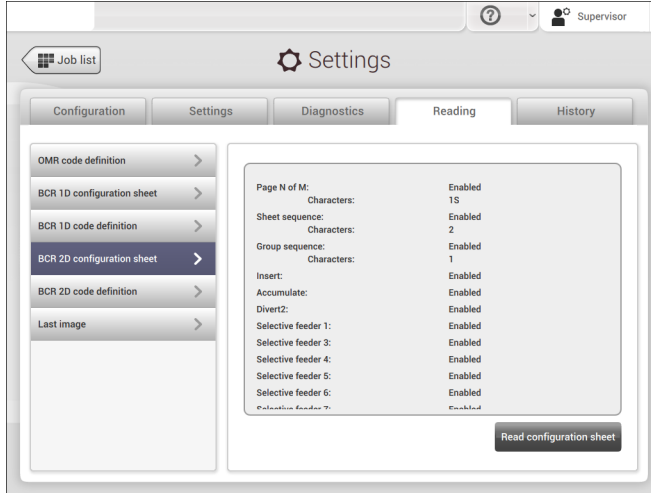

English

The Reading BCR 2D configuration sheet allows you to read a configuration sheet. The result is visible in this screen, but also in the BCR 2D code definition screen. See [Reading a configuration sheet](#) on page 115.

BCR 2D Code Definition

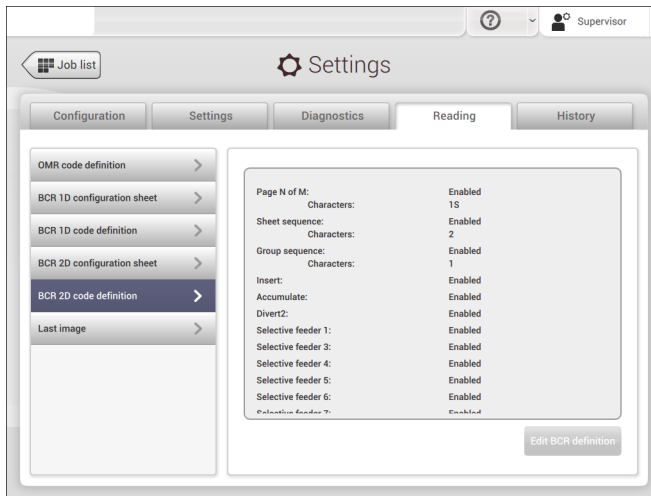

The BCR 2D code definition screen shows only information when a configuration sheet is read. It shows which codes are enabled and how they work.



Last Image

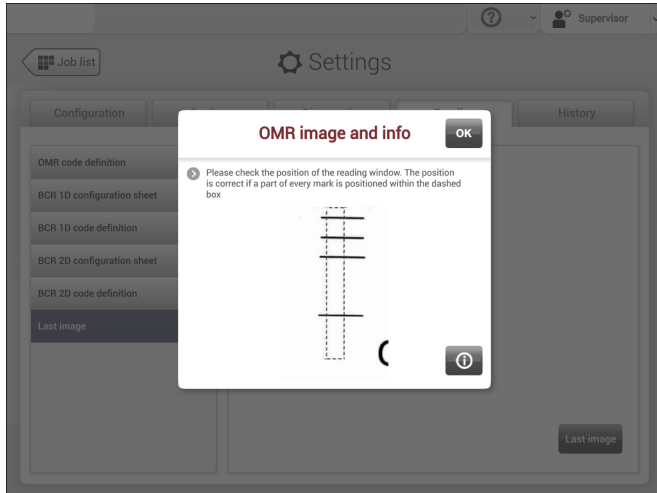

The Last image screen shows the result of the last code that the system read. The figure shows an example of the image of an OMR code. You can use this image to see if the read code fits within the reading window.

When you click on the Information button of an image of OMR code, the screen shows a graphical representation of the marks read from the last OMR document (oscilloscope function). It shows the time-dependant OMR output voltage.

6

English

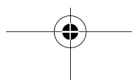

History

The History screen shows an overview of the jobs run.

1. Tap on the **[History]** tab to view the Job history.

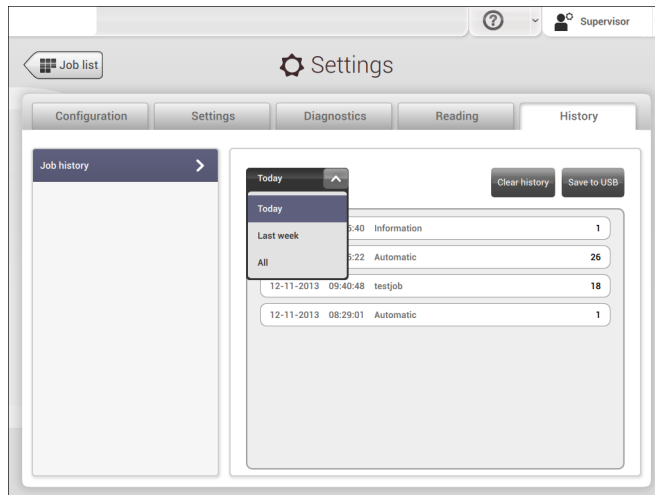

2. Tap on the **[Today]** pull down button if you want to view the jobs that are run 'Today', 'Last week' or 'All'.

The history is displayed on the touch screen. With **[Save to USB]**, you save the history in CSV format to a USB drive. The USB connector **A** is located at the control panel.

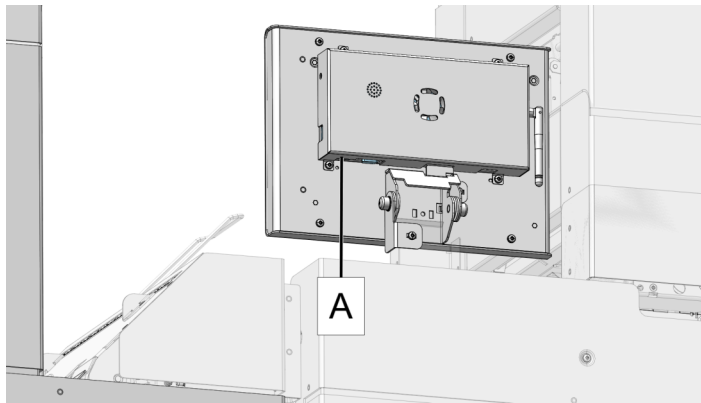

6

English



7 Connect the System to the Internet

Options for Connection

Connect the system to the internet in one of the following ways:

- Wired connection with the gigabit ethernet connection:
 - Connect with DHCP (Automatic IP address)
 - Manual Configuration
- Wireless connection:
 - Search for SSID
 - Manually configure SSID

In all cases, you can use proxy for the connection.



Log on as Supervisor to complete this procedure.

Set up a Wired Connection

Set up a wired connection as follows:

1. Connect the system to a LAN with a network cable. The figure shows the LAN connector on the display module (**A**).

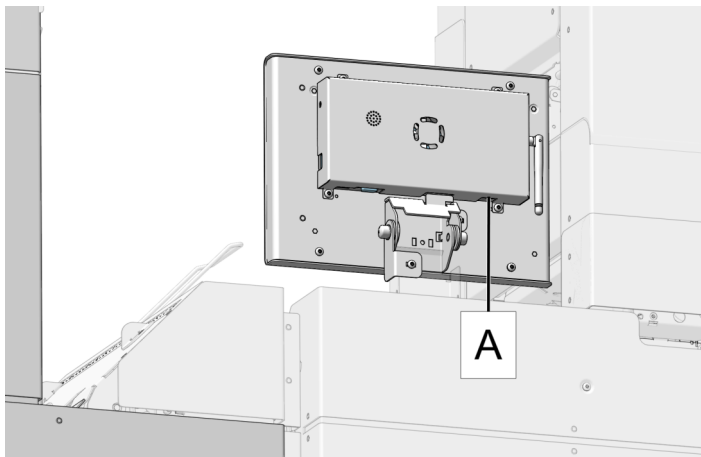

7

English

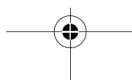

2. Open the supervisor settings menu.
3. Tap the Settings tab, [**Connectivity**].
4. Tap [**LAN settings**].

7
English

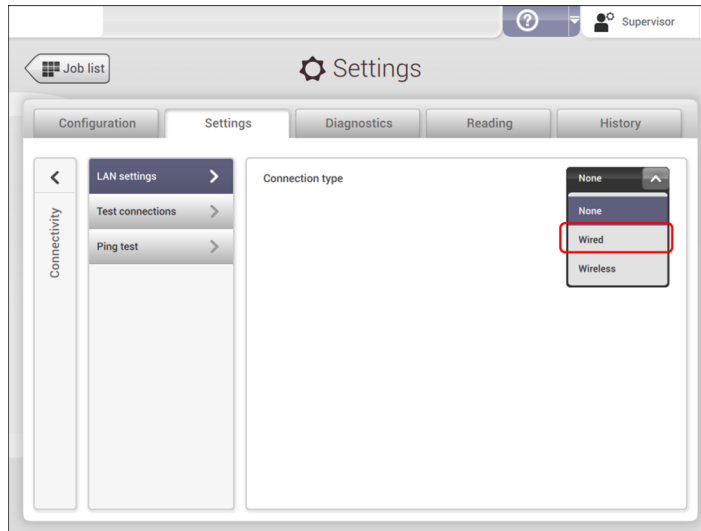

5. Select Wired from the Connection pulldown menu.

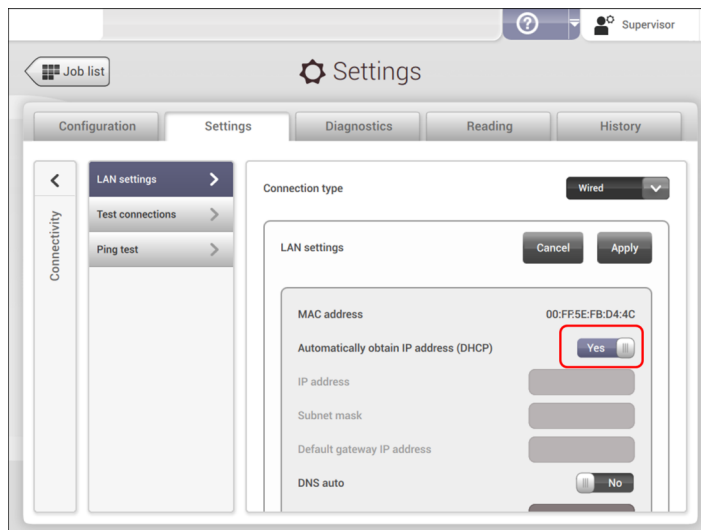

6. Set Automatically obtain IP address (DHCP) to Yes or No. If Yes, the system connects automatically to the LAN. If No, set up a connection manually. Enter the necessary details to setup a manual connection.

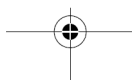

Set up a Wireless Connection

Set up a wireless connection as follows:

1. Open the supervisor settings menu.
2. Tap the Settings tab, [**Connectivity**].
3. Tap [**LAN settings**].

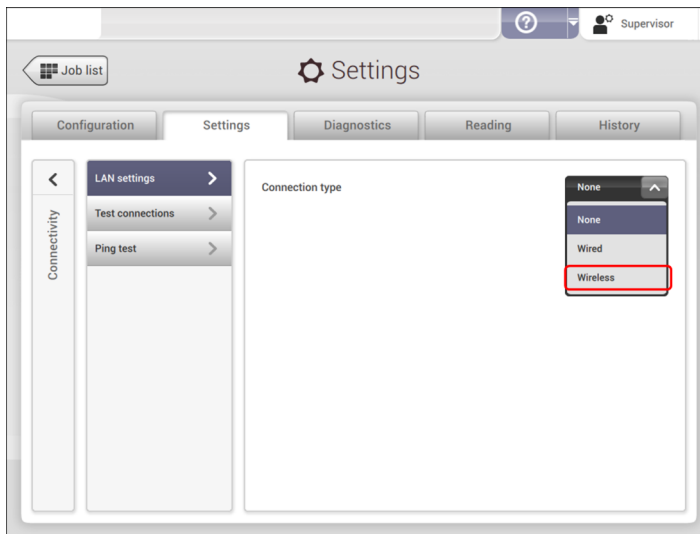

4. Select Wireless from the Connection pulldown menu.

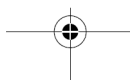
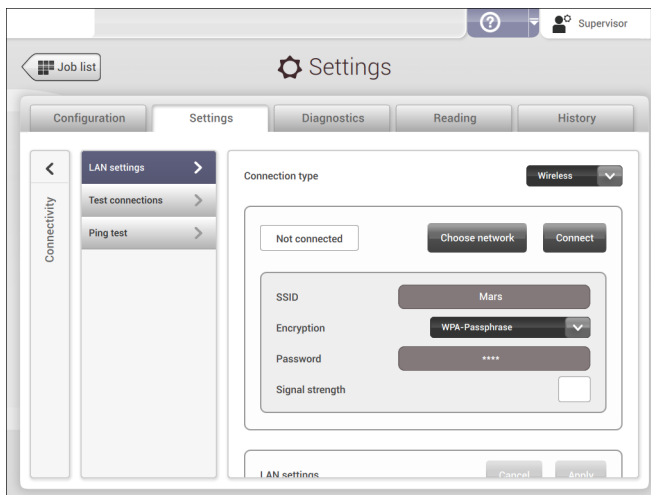

5. Choose if you want to enter the SSID manually or if you want to search for a wireless network. If you want to search for a network, tap [**Choose network**].
6. When you have entered the network details or selected a network from the search, tap [**Connect**] to connect to the network.

When the system connected successfully to the network, the screen shows Connected.

7
English

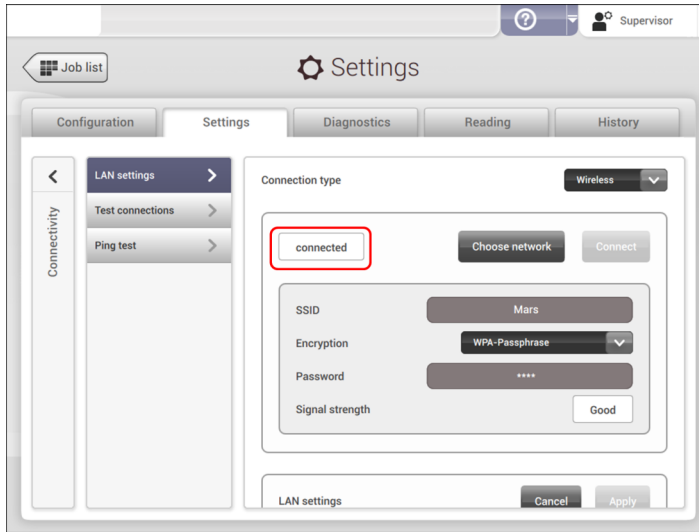

Test the Connection

When you have connected to a network, test the connection as follows:

1. Open the supervisor settings menu.
2. Tap the Settings tab, [**Connectivity**].
3. Tap [**Test connections**].

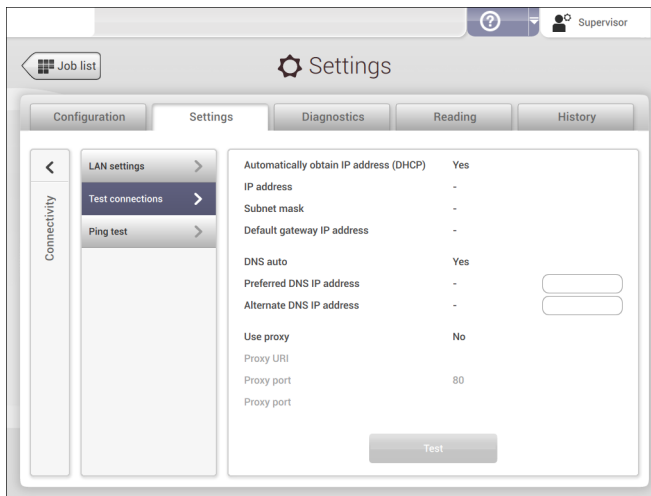

4. Tap the [**Test**] button.

The system tests the IP addresses that are defined at the LAN settings. If the result is 'Not OK', make sure that the settings are correctly defined.



8 Reading

Introduction

Code Types

The reading option allows the system to read special codes that are printed on the documents. The code contains information about the processing of the documents.

The system can read the following code types:

- OCR: Optical Character Recognition; the system can scan an area of the document for page number information in the page "n of m" (n/m) format
- BCR 1D: One dimensional barcode
- BCR 2D: Two dimensional barcodes
- OMR: 1-track Optical Mark Recognition
- Flex 1-9: Optional translation to support non standard OMR and BCR coding

Depending on the settings, the code tells the system if:

- The document set is complete
- Enclosures must be added to the set
- The system must stop
- The set is complete (no pages are missing)
- The envelopes are transported to the side exit or to the stacker

The sheets with the printed code are placed in a feeder. Depending on the programmed code, the other feeders can be used as selective feeders to add enclosures.

In case of a Z-fold, the address has to be printed on the last page of the set (see [Document orientation](#) for the code position). With the other fold types, the first sheet of a set always contains the address. A full length code is printed on every sheet of a set. The code must appear at the same location on every page regardless of the actual code length.

The code on the last sheet of the set contains the insert instruction (unless reverse reading is used, see [Reading settings](#), [Reverse reading](#) on page 119). The other sheets carry the accumulate instruction. If the "page n of m" code is used with BCR or OCR, the set will be inserted when n equals m.

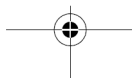

General Requirements for Printing Codes

If you print documents for reading:

- Make sure the ribbon or toner quality is sufficient.
- Print the code in black on white background.
- Codes on the same sheet must have equal intensity.
- Print the code at the same position on every sheet.
- Be aware of "background noise". The reading function can be disturbed by: color changes on the form, background design and a logo or copy on the opposite side of the sheet that will bleed through.
- For matrix printers near letter quality (NLQ) printed characters are preferred to obtain maximum blackness (double strike).



For more information on how to print a reading code on your document, contact your service organization.

88

OCR Code Description

With OCR page n / m (page n of m) you can print human readable characters on your mail set, which can be read by the system, to insert your mail set. The system can recognize the characters in the so called "n / m" format.

If the value of n is smaller than the value m the sheet will be accumulated, if the value of n is the same as the value of m the set will be inserted; m is the total number of pages and n is the current page.

Some specifications for OCR page n / m:

Supported fonts / font size	Times New Roman, Arial, Helvetica, Courier. Italic text will not be supported, bold not recommended.
Character size	12 point dotpitch
Supported layouts	n / m (n,space,/,space,m) Both n and m need to be in the text, n first.
Print Quality	600 dpi (preferable)
Clear Area	15 mm (minimal), around
Color Background	White
Print drift	+/- 2 mm (max.)

English

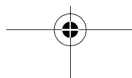

Positions	Only one region of interest per job Only horizontal text (portrait) supported All text on the same line Position on the page: as is BCR/OMR
-----------	--

Example:

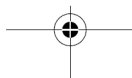
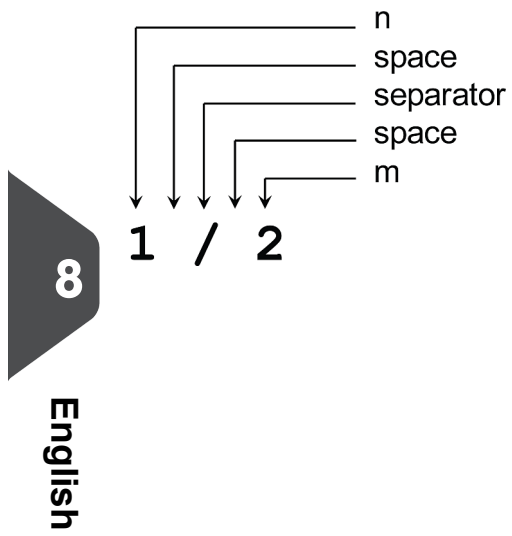

Position of the code on the document (example)

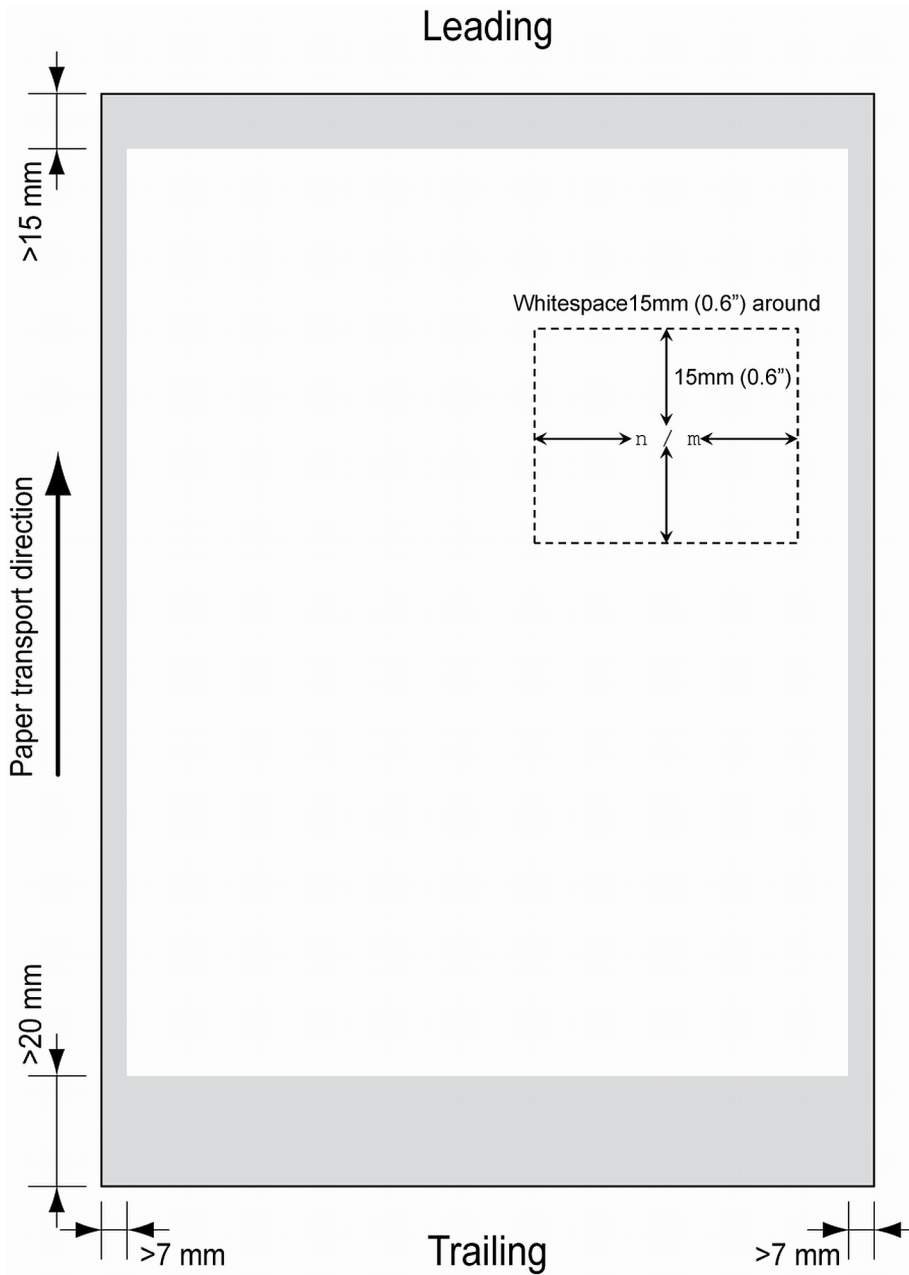

English

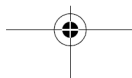

BCR Code Description

Bar codes are used for mail sets that are processed in Document Systems. The bar codes tell the system if:

- The document set is complete
- The envelope should be sealed
- Enclosures should be added
- Etc.

Barcode can be printed vertically and horizontally. Two types of barcodes are supported, 1D and 2D barcodes (depending on installed licenses).

Supported 1D barcodes

- Code 39



- Code 128



- Interleaved 2 of 5



- Minimum line thickness of a bar: 0.25 mm (0.01 inch)
- The thickness ratio of thick bars versus thin bars: 2.2
- Minimum width of the barcode: 5 mm (0.2 inch)
- The white area in the picture shows the limits where the code can be printed



English

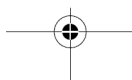

Supported 2D barcodes

•

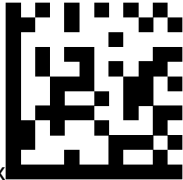

- Minimum cell size 0.35mm (0.014")
 - Label size 30mm (1.18") square max.
 - Preferred print quality 600dpi
 - Print drift from page to page +/-2mm max.
 - Colour background: White
 - Minimum white space 6.5mm (0.26")
- Datamatrix can be read in all directions.

•



- Bar width 0.35mm (0.014") min.
- Preferred print quality 600dpi
- Print drift from page to page +/-2mm max.
- Colour background: White
- Minimum white space 6.5mm (0.26")

Printing contrast The label must be strongly printed in black on white background for maximum contrast. Other light backgrounds may be acceptable, subject to test.



English

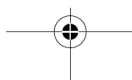

Position of the code on the document

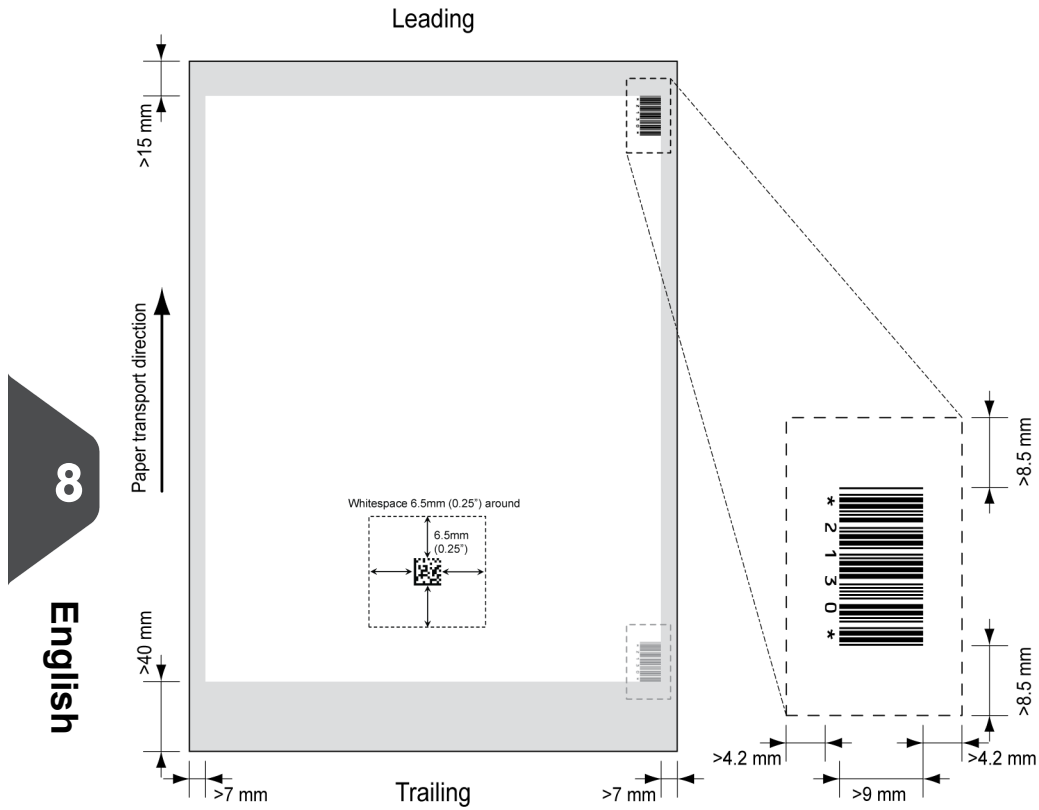

BCR license types

There are two BCR license types:

- Basic
- Advanced

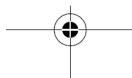

BCR basic license

For the BCR basic license the following functions are available:

- Page N of M: as long as N is below M, the document set is not complete. As soon as N=M, the set is complete and will be inserted into an envelope.
- Insert/Accumulate: defines when a document set is complete and must be inserted into an envelope.
- Customer ID: BCR uses the Customer ID code to complete a set. If the ID changes, the set is inserted. This is only possible with reverse reading.

At least one basic commands is required. Page N of M can be used in combination with Customer ID as an integrity check.

BCR advanced license

For the BCR advanced license the following functions are available:

- The basic functions (page N of M, insert/accumulate, Customer ID)
- Sheet sequence - Every sheet has a number, regardless of the document set it is part of. If a sheet is missing, an error is generated.
- Group sequence - Every document in a set has the same group number. If one document set is missing, an error is generated.
- Divert (Divert & Continue) - The set will be diverted and the system continues.
- Stop (Divert & Stop) - The set will be diverted and the system stops indicating error (FT1-RE1-000 Reading stop - Stop mark read).
- Selective feed - If the system reads the command, an enclosure from the enclosure feeder is added to the set. This function is printed on the last sheet of a set. It is also possible to add an enclosure from the Thin Booklet Feeder.
- Sealing control - Determines if envelopes are sealed or not.
- Present on Deck & Continue - The set leaves the system from the upper unit. The system does not stop processing. The envelopes are not sealed.
- Present on Deck & Stop - The set leaves the system from the upper unit. The system stops. The envelopes are not sealed.
- Exit selection - Determines if the envelope is transported to stacker or to the side exit.

88

English

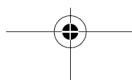

OMR Code Description

Position of the code on the document

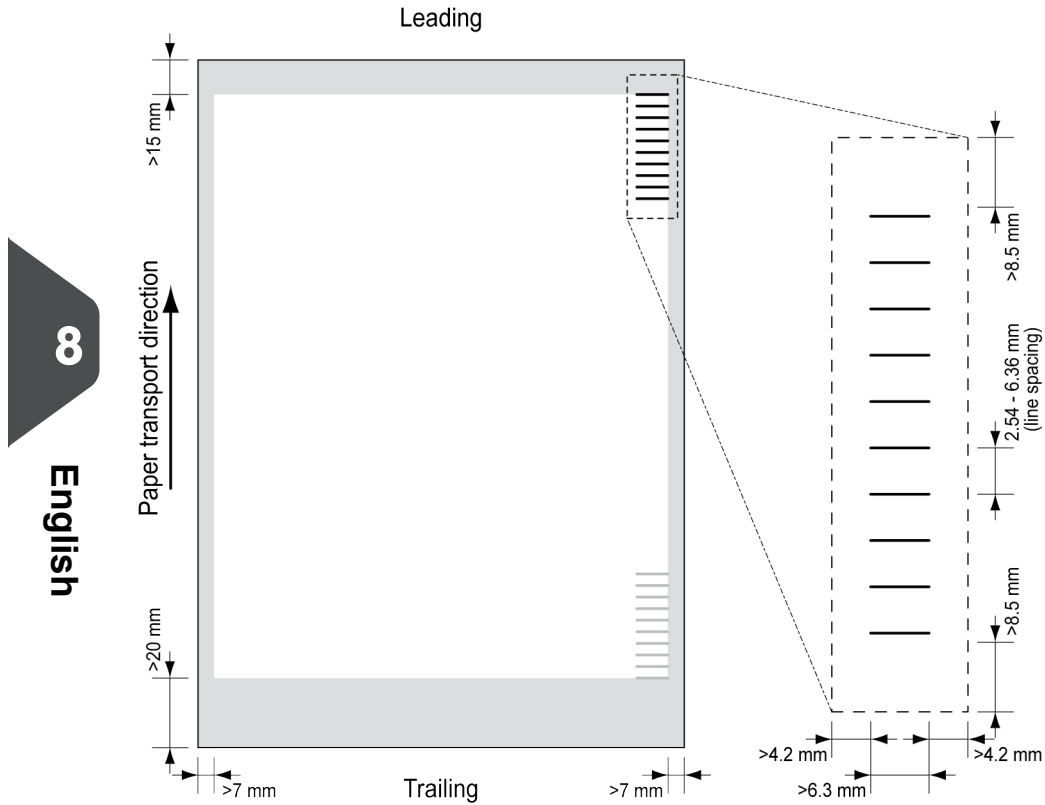

Minimum line thickness of a mark: 0.2 mm (0.008 inch)

Default the first mark from the top is set to: 100 mm (3.9 inch). This parameter is set in the job settings.

The code must have a consistent number of marks on every page.

The white area in the picture shows the limits where the code can be printed.

OMR license types

There are two OMR license types:

- Basic
- Advanced

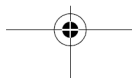

OMR basic license

For the OMR basic license the following functions are available:

- Start mark: indicates the start of the code.
- Insert/Accumulate: defines when a document set is complete and must be inserted into an envelope.
- Parity check: by adding a parity mark the reading code can be checked. The sum of the marks must be even.
- Safety Mark: is used as an extra security (only 1-track OMR). With skewed paper the reading head can miss part of the reading code. In these situations the safety mark is not read, and the system will give an error. The safety mark also indicates the end of the reading code. This mark must always be present on the document if it is part of the code definition.

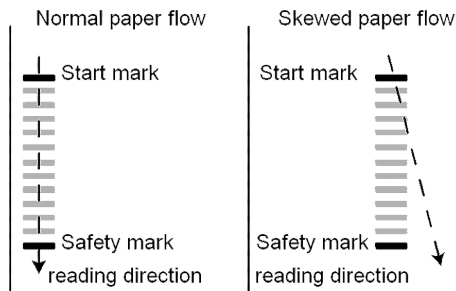

The minimum code is one mark in one line (insert). However for reliability it is advised to use at least 2 marks. The first line is the start mark. A mark printed on the second line means insert. No mark on the second line means accumulate.

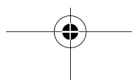

OMR advanced license

For the OMR advanced license the following functions are available:

- The basic functions (Start, Insert, Parity, Safety)
- Divert (Divert & Continue) - The set will be diverted and the system continues.
- Stop (Divert & Stop) - The set will be diverted and the system stops indicating error (FT1-RE1-000 Reading stop - Stop mark read).
- Selective Feed (feeder 1-6 and the Thin Booklet Feeder) - If the system reads the command, an enclosure from the enclosure feeder is added to the set. This function is printed on the last sheet of a set.
- Exit control - Determines if the envelope is transported to stacker or to the side exit.
- Present on deck - The set leaves the system from the upper unit. The system does not stop processing. The envelope is not sealed.
- Present on deck and stop - The set leaves the system from the upper unit. The system stops. The envelope is not sealed.
- Sealing control - Determines if envelopes are sealed or not. If a mark is printed, the envelope is not sealed.
- Sequence Check - Sheets in a stack can accidentally get out of sequence or can be missing. This can be detected by the sequence check. Each sheet has a binary code that is a part of the reading code. Depending on the application one, two or three marks are used by sequence check.



English

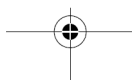

OMR general remarks

General remarks:

- In case of OMR the marks must always be used in the sequence as shown in the figure.

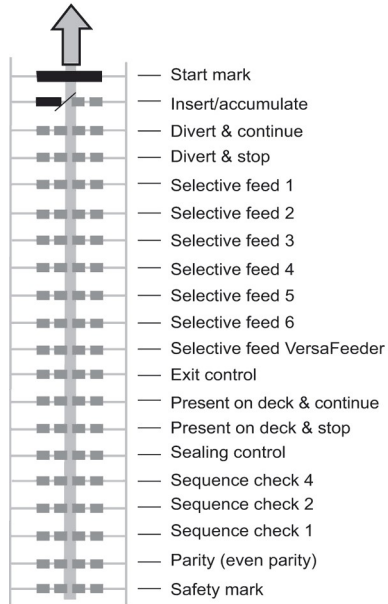

- If a function is suppressed the following function will move upwards one line.
- The mark definition is a service setting.



English

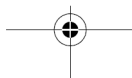

An Example of OMR Code

In the figure the legend for the following example is shown. In this example, a set of 8 sheets with one selective feed and three sequence check marks is shown.

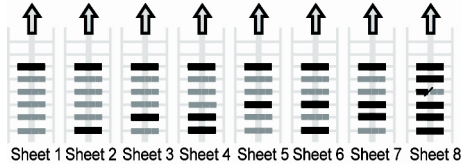

- The first position is used for the start mark which must be printed on every sheet.
- The second mark position is used for the insert/accumulate command. A printed mark means insert, no mark means accumulate. Therefore the mark is printed on the last sheet of the set.
- Position 3 is reserved for selective feed from the enclosure feeder. Print a mark on position 3 when a selective feed from the enclosure feeder is required. The marks are printed on the last sheet of the set.
- Position 4, 5 and 6 are used for the sequence check marks. In this case a three mark sequence check is used.



English

Flex Reading Code Description

With "Flex reading" also non-standard codes and alternative document handling algorithms can be recognized. Flex reading can be activated by a system specific license code and by a customer specific setting that is saved in a physical dongle.

With Flex three types of reading can be supported:

- OMR
- BCR 1D
- BCR 2D

Depending on the license up to 9 Flex definitions can be used on the system. Creating a Flex job is similar like creating a OMR / BCR reading job.

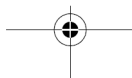

Create Jobs with Reading

Create an OCR Job

To create a job with OCR:

1. From the Job list menu, tap **[New job]**.
2. Choose **[Manual]** to define the job settings.
3. Select an envelope.
4. Tap **[Main document]**.
5. Tap **[Custom]**.
6. Enter the document size or select a standard type.
7. Tap the **[Reading]** tab.

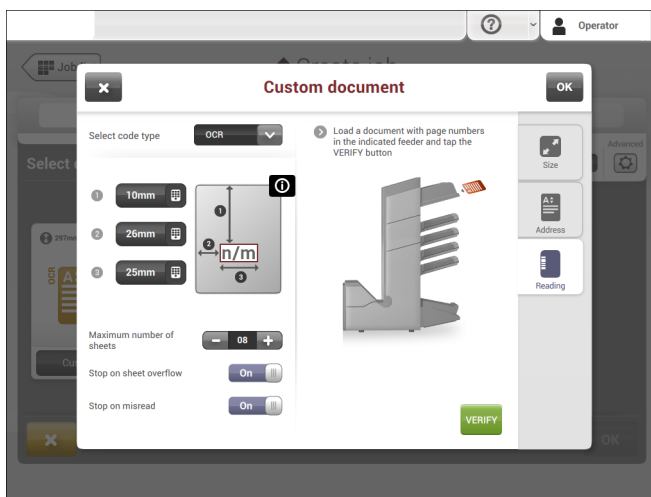

8. Select the code type **[OCR]**.
9. Configure the location of the n / m characters by setting the offset of the top and left side of the sheet **[1]** and **[2]**.
10. Configure the width of the n / m characters **[3]**.
11. Load a sample document in the feeder tray as indicated.
12. Tap **[Verify]** to check if the page n / m characters are read successfully.

88

English

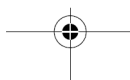

13. Tap **[OK]** and follow the remaining steps to complete the job.
14. When you completed the job creation, tap **[Save]** to save job.

If required the maximum number of sheets, stop on sheet overflow and stop on misread can be reconfigured. Refer to [Reading Settings](#) on page 119 for more details on how to change these settings.

Create a BCR Job

To create a job with BCR:

1. From the Job list menu, tap **[New job]**.
2. Choose **[Manual]** to define the job settings.
3. Select an envelope.
4. Tap **[Main document]**.
5. Tap **[Custom]**.
6. Enter the document size or select a standard type.
7. Tap the **[Reading]** tab.
8. Select the code type **[BCR 1D]** or **[BCR 2D]**.

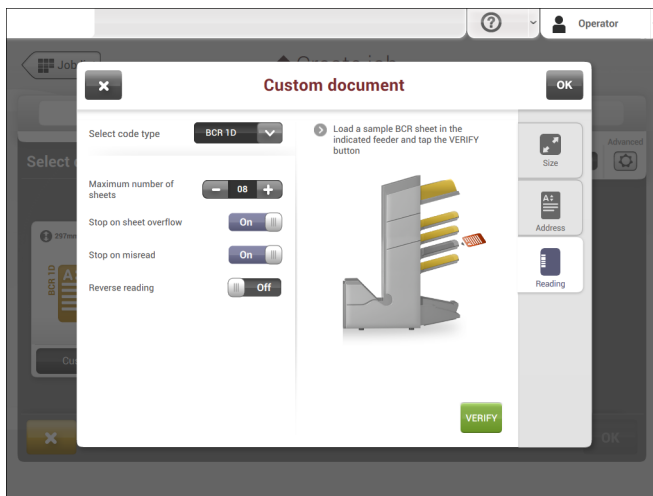

9. Load a sample document in the feeder tray as indicated.
10. Tap **[Verify]** to find the barcode(s) on the sheet.
 - If multiple barcodes are found you can select the correct barcode from the list.

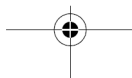

11. Tap **[OK]** and follow the remaining steps to complete the job.
12. When you completed the job creation, tap **[Save]** to save job.

If required the maximum number of sheets, stop on sheet overflow, stop on misread and reverse reading can be reconfigured. Refer to [Reading Settings](#) on page 119 for more details on how to change these settings.

Read a Configuration Sheet

If you want to set the code definition for BCR, use a BCR configuration sheet. The configuration sheet function is available when you are logged on as a [supervisor](#) on page 3.

To read a configuration sheet:

1. Go to the settings menu for supervisor, see [Opening the settings menu \(supervisor\)](#) on page 76.
2. In the settings menu, tap the **[Reading]** tab.

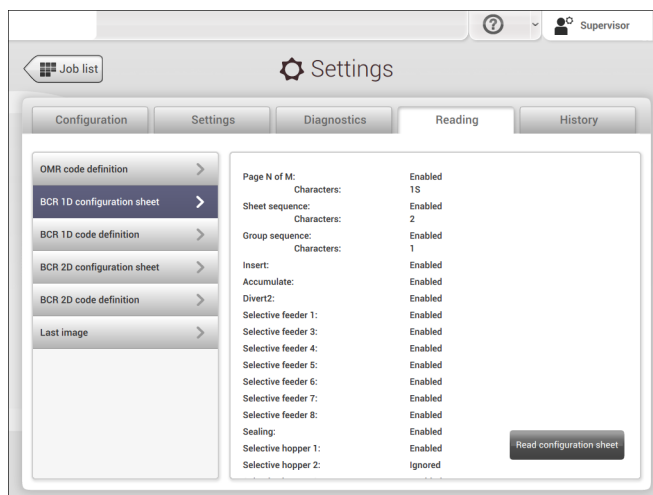

3. Tap **[BCR 1D configuration sheet]** or **[BCR 2D configuration sheet]**.
4. Tap **[Read configuration sheet]**.



English

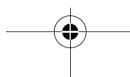

5. Load the configuration sheet as indicated and tap **[READ]**.

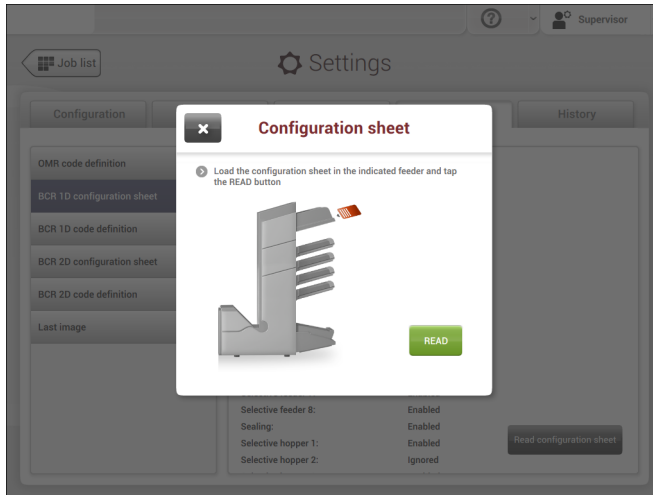

6. Tap **[Save]** to save the new barcode definition.



After reading a configuration sheet, jobs with BCR reading might have changed. These jobs are marked with an exclamation mark, verify the job settings before running the job.

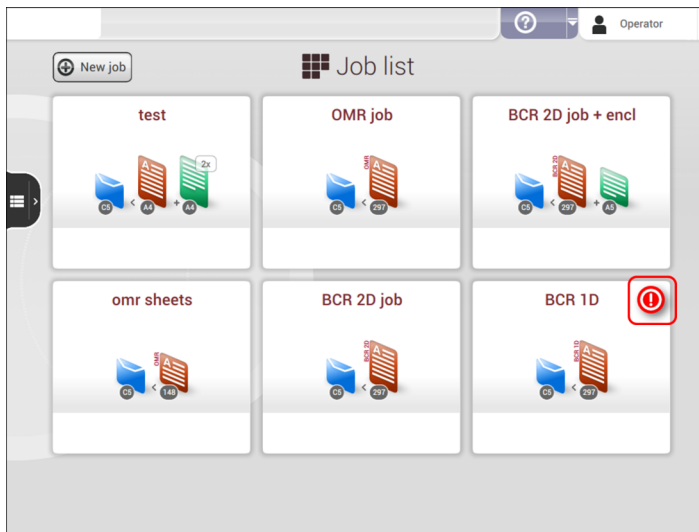

You can also read a configuration sheet when you create or edit a BCR job. The function is available in the side menu.

88
English

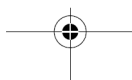

Create an OMR Job

To create a job with OMR:

1. From the Job list menu, tap **[New job]**.
2. Choose **[Manual]** to define the job settings.
3. Select an envelope.
4. Tap **[Main document]**.
5. Tap **[Custom]**.
6. Enter the document size or select a standard type.
7. Tap the **[Reading]** tab.

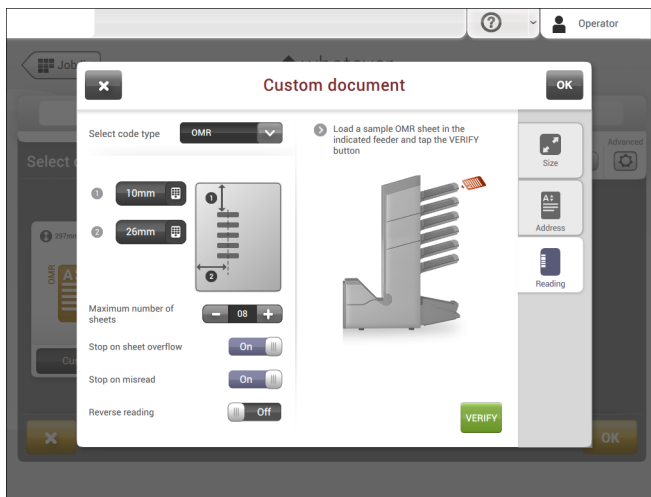

8. Select the code type **[OMR]**.
9. Configure the location of the OMR marks by setting the offset of the top and left side of the sheet.
10. Load a sample document in the feeder tray as indicated.
11. Tap **[Verify]** to read an example sheet to check the correct reading of the OMR marks.
12. If necessary adjust the position from top and from left side. Verify again with a sample sheet.

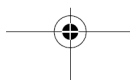

13. Tap the information button to verify the read OMR marks.

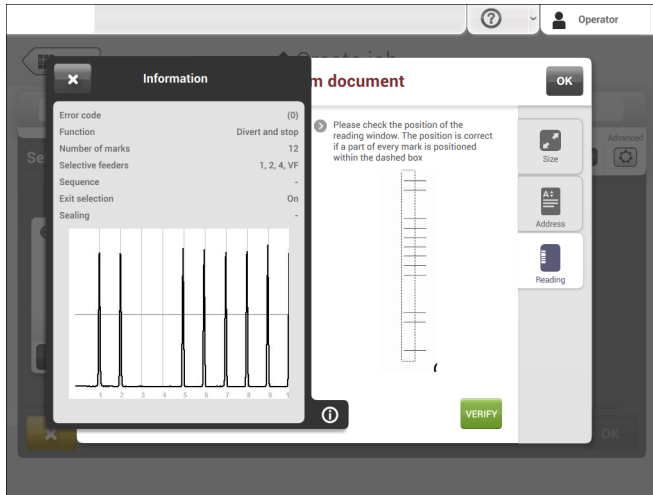

14. Tap [OK] and follow the remaining steps to complete the job.
15. When you completed the job creation, tap [Save] to save job.

If required the maximum number of sheets, stop on sheet overflow and stop on misread can be reconfigured. Refer to [Reading Settings](#) on page 119 for more details on how to change these settings.

English

Create a Flex Reading Job

To create a job with Flex reading:

1. From the Job list menu, tap [New job].
2. Choose [Manual] to define the job settings.
3. Select an envelope.
4. Tap [Main document].
5. Tap [Custom].
6. Enter the document size or select a standard type.
7. Tap the [Reading] tab.

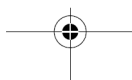

8. Select the code type [**Flex ..**].

 Depending on the flex code type the OMR or BCR settings have to be configured.

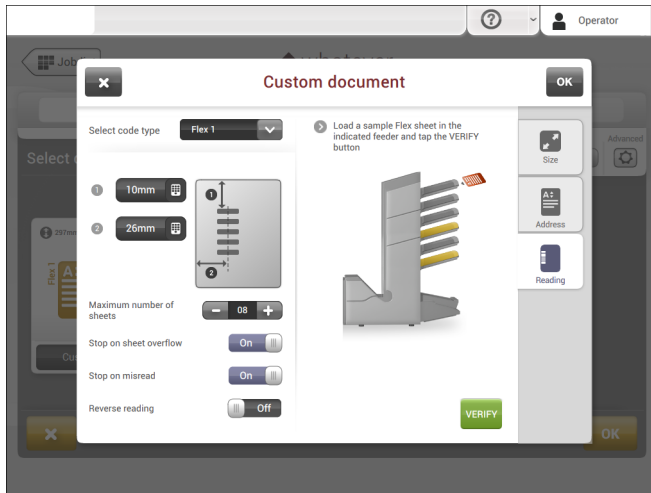

9. Follow the remaining steps to complete the job.

If required the maximum number of sheets, stop on sheet overflow and stop on misread can be reconfigured. Refer to [Reading Settings](#) on page 119 for more details on how to change these settings.

Reading Settings

When you create a reading job for OCR, OMR, BCR 1D/2D or Flex reading, the following options can be set:



English

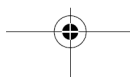

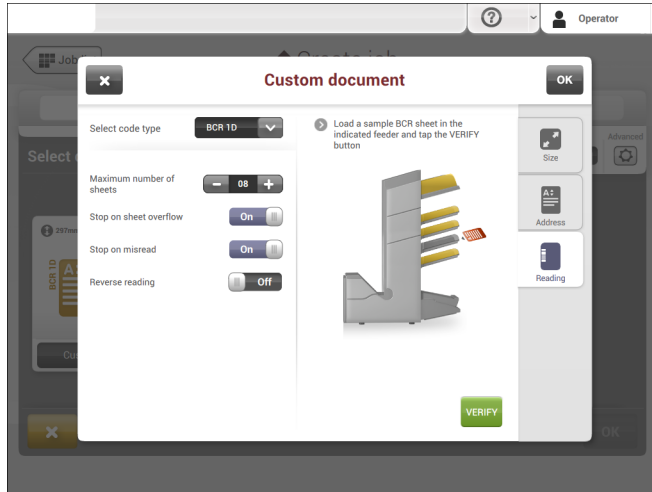

English

- **Maximum number of sheets:** use the [-] or [+] button to select the maximum amount of sheets in the set of documents.
- **Stop on sheet overflow:** defines if the system should stop or not when a set exceeds the maximum number of sheets, as defined at the "Maximum number of sheets setting".
In case of "on", the system stops when the number is exceeded. The incorrect set is diverted. After resetting the system, the final part of the set is also diverted and the system starts processing again. The diverted set should be checked by the operator.
In case of "off", the system does not stop when a set exceeds the maximum number of sheets. The incorrect set is diverted. The final part of the set is also diverted and then the system starts processing again.

 The maximum number of sheets in a set is 25. When the number of sheets exceeds 8 or 10, depending on the fold, the document can not be folded anymore. In this case, the maximum length of sheets is 148 mm for a C5/6 envelope. Also make sure that the fold is set to No fold. Ignoring this will certainly lead to stoppages.

When the maximum number of sheets exceeds the programmed maximum number of sheets in a set, the system stops and error FT1-RE1-312 will be displayed. After removing the set and tapping the **[Start]** button, the system starts and repeats the process until an insert or divert mark is encountered. Error FT1-RE1-003 (final set part) will be displayed.

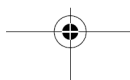

- **Stop on misread:** defines if the system should stop or not when a code is misread. In case of “**on**”, the system stops after a misread. The incorrect set is diverted. After resetting the system, the final part of the set is also diverted and the system starts processing again. The diverted set should be checked by the operator. When “Stop on misread” is set to “**off**”, the system does not stop after a misread. The incorrect set is diverted. The final part of the set is also diverted and then the system starts processing again. After 5 misreads in a row, the system stops and an error code is generated.
- **Reverse reading:** (not applicable for OCR)
With Reverse reading the decision of inserting a mailset is marked on the next set. For example with OMR the insert mark is printed on the first page of the set. The system will detect the end of a set by detecting the first page of the next set. For example in case of BCR using the Customer ID to complete a set. If the ID changes, the set is inserted.
In case the feeder runs empty, the last set is still on the collator because the beginning of the next set could not be detected. In this case the feeder empty message contains an **[Ignore]** function. Tap **[Ignore]** and the set on the collator will be inserted. Because of the feeding and collating principle reverse reading has the following limitations:
 - The last mark of the code should be printed maximally 85 mm (3.3 inch) from the top.
 - Enclosures and selective enclosures cannot be handled. When a Thin Booklet Feeder module is added to the system configuration, enclosures and selective enclosures can be handled with reverse reading.

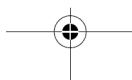

Exit Selection with Reading

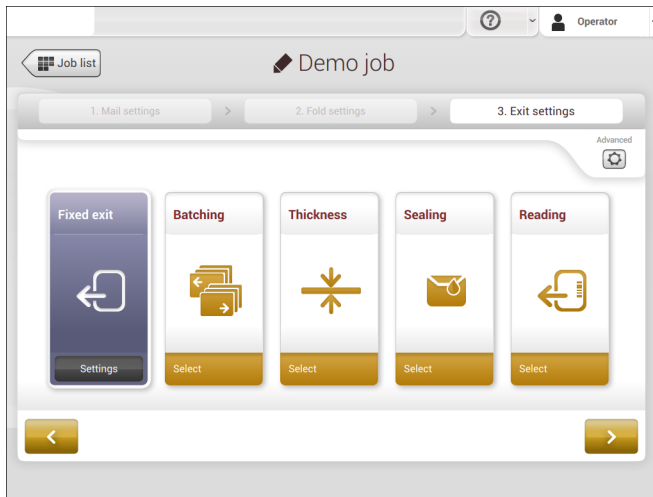

When you have a job with

reading, more exit selection options are available:

- **Fixed Exit:** tap **[Settings]** to select which exit must be used for this job. If you select stacker, you can choose to let the system continue on the side exit if the stacker is full.
- **Batching:** tap **[Settings]** to define after what number of mail sets, the system must switch to the other exit. In case of a reading job, you can switch off that the system changes the exit on a reading mark.
- **Thickness:** depending on the thickness of the document set, the envelope exits to the stacker or the side exit. Tap **[Settings]** to define the exit when the mail set is thicker or thinner than the reference. The reference is the first document set.
- **Reading:** reading has two options: switch exit on mark and let the code define which exit is used. Switch exit on mark means that at every exit code the system changes the exit. If the code defines the exit, you define what happens if the exit code is read: exit code means stacker or exit code means side-exit.
- **Sealing:** depending on if the envelopes are closed (sealed) or open (not sealed), the envelope exits to the stacker or the side exit. This selection is only possible with reading: no mark (space) means sealed, a mark means not sealed.

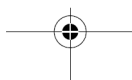

9 Operator Maintenance

Maintenance Schedule



Disconnect the mains power supply before performing any maintenance.

The user must not attempt to service the appliance beyond that described in this operator manual. All other servicing must be carried out by qualified service personnel only.

Please contact your authorized distributor.

Maintenance frequency	Maintenance recommended
Daily	<ul style="list-style-type: none"> • Check the system functions. • Keep the system in proper condition by removing dust, paper remains, etc.
Weekly	<p>The machine is delivered with an extra set of brushes. To always have one clean set available, it is recommended to soak one set in water and use the other set.</p> <ul style="list-style-type: none"> • When dirty or saturated, clean the brushes of the envelope sealing or replace them (see Clean and replace brushes). • When dirty or saturated, clean the moistening cloth or replace if necessary (see Replace moistening cloth). • Clean feed and insert rollers as instructed by the Service Engineer.
As necessary	<p>When the display warns about dusty sensors, clean the applicable sensors. After cleaning, always calibrate the photocells (see Calibrate photocells on page 126).</p>

9
English

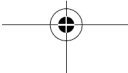

Clean and Replace Brushes

When dirty or saturated, clean the brushes of the envelope sealing or replace them as follows:

1. Moisten the new brushes in water.
2. Lift the unlocking lever A of the upper unit and pull up the upper unit.

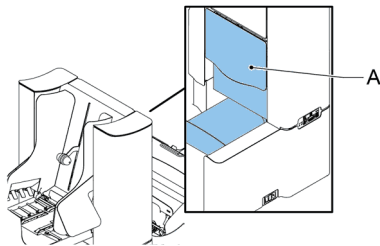

3. Remove the brushes one by one by pulling them down from the brush holder.

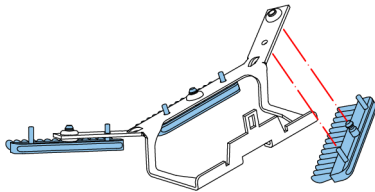

4. Replace the brushes. Make sure that the studs on the brushes are fitted in the corresponding holes in the brush holder.
-

6

English

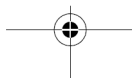

Replace or Clean Moistening Cloth

When dirty or saturated, clean the moistening cloth or replace if necessary. Proceed as follows:

1. Open the front cover **A**.

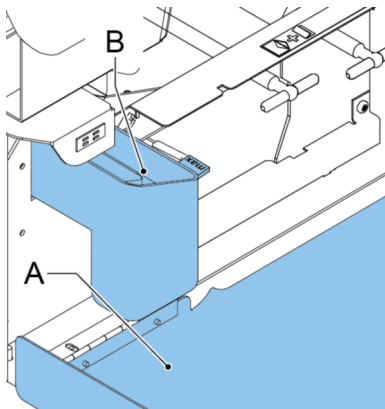

2. Remove the sealing liquid reservoir **B** from the system.
3. Remove the cover with moistening cloth **D**.

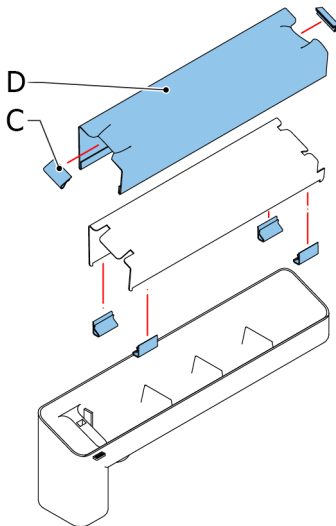

4. Remove clips **C** to remove the moistening cloth.
5. Clean or replace the cloth.



English

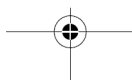

Calibrate Photocells

When too much paper dust is built up at the sensors, a warning message is displayed. In that case, calibrate the photocells as follows:

1. Log in as supervisor.
2. In the settings menu, tap the **[Diagnostics]** tab.
3. Tap **[Maintenance]**.

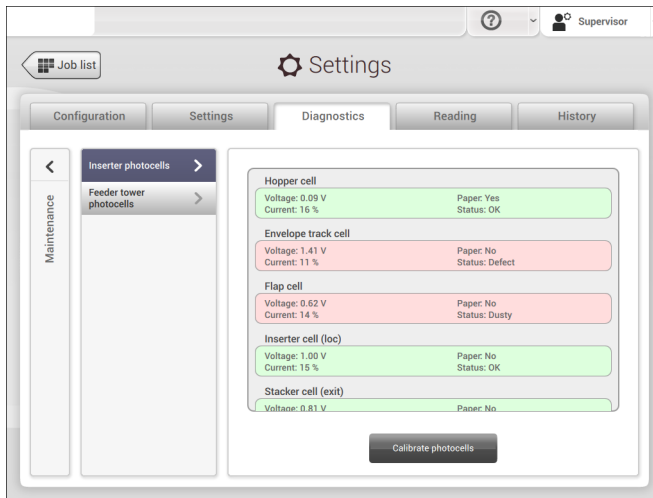

4. Choose which photocells you want to calibrate.
 5. Remove all documents and envelopes and close all covers before starting the calibration.
 6. Tap **[Calibrate sensors]**.
-

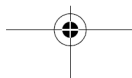

10 Fault Finding

Messages

Introduction

There are three different types of messages:

- Indications
- Warnings
- Errors

Indications

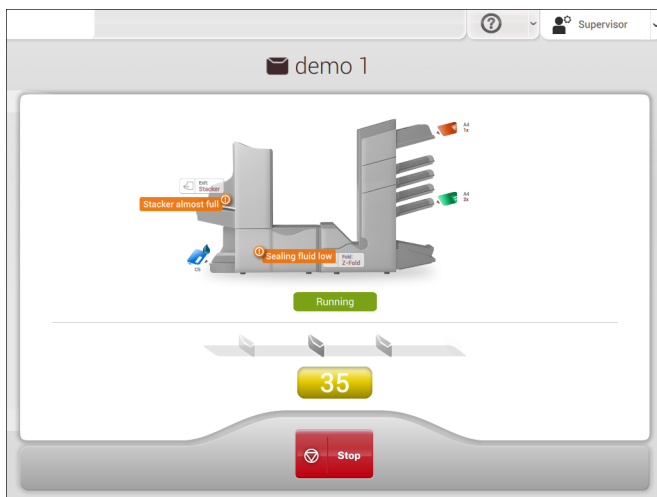

When you run a job, indications can appear like the ones in the example.

10

English

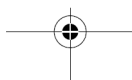

Warning message

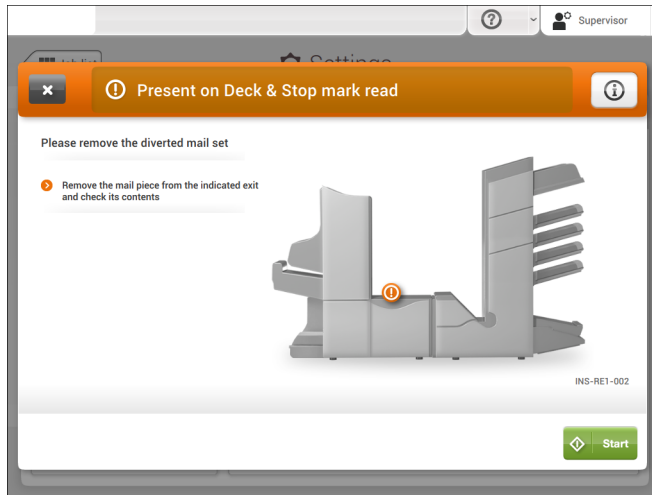

10

English

When a warning message is shown, the screen shows the following information:

- An indication of the area in which the event occurred
- A warning description
- A suggested solution behind the arrow
- An event message number; use this number in case that you call support

Tap the [i] button to view more information about the event.

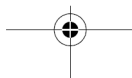

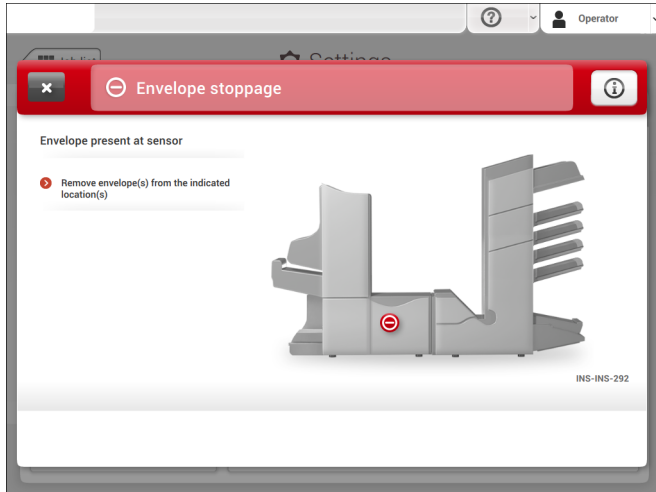

When an error occurs the touch screen shows a screen with the following information:

- An indication of the area in which the error occurred
- An error description
- A suggested solution behind the arrow
- An event message number; use this number in case that you call support

Tap the **[i]** button to view more information about the occurred error and about the possible actions to avoid the error from re-occurring.

After solving the problem, tap **[x]** to reset the error (the error screen will disappear).

Special Errors

- Reading errors (when reading is enabled)
The document set is diverted. The operator must remove the document set and has to complete the set manually!
- Technical errors
The display shows a message. The error cannot be solved by operating personnel and assistance of the service support is needed.

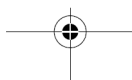

Clear Stoppages

For clearing of stoppages, five system sections can be opened:

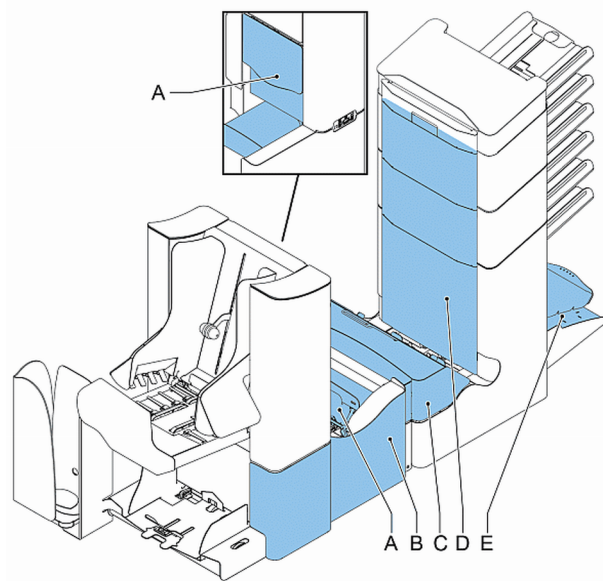

10

English

- A - loc, to reach the exit, sealing and inserting area
- B - side cover, to reach the lower envelope track
- C - Folding Unit cover, to reach the folding area
- D - vertical transport cover, to reach the vertical transport and feeding area

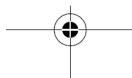

E - collator arm, to reach the collating area

Envelope Hopper

When an envelope gets stuck in the envelope hopper, remove the envelope as follows:

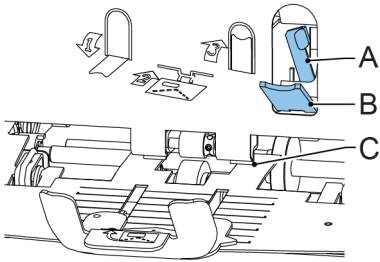

1. Pull down small lever **B**. Pins **C** will come down.
2. Push lever **A** to the right and hold it. Pins **C** will go up.
3. Remove the stuck envelope.
4. Release lever **A**.
5. Make sure the separation setting is still correct (see [Loading Envelopes](#)).
6. Return lever **B**.
7. Tap **[x]** to reset the error and restart the job.

Exit, Sealing and Inserting Area

When a stoppage occurs in the exit, sealing and inserting area, remove the material as follows:

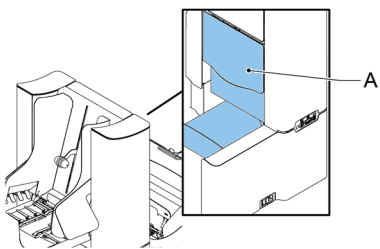

1. Lift the unlocking lever **A** of the upper unit and pull up the upper unit.
2. Remove all material.
3. Close the upper unit.
4. Tap **[x]** to reset the error and restart the job.

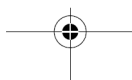

Lower Envelope Track

When a stoppage occurs in the lower envelope track, remove the envelopes as follows:

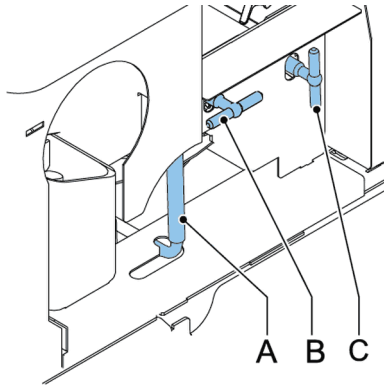

10

English

1. Open the side cover.
2. Pull down the blue handle **A**.
3. Remove the envelope(s) from the lower envelope track.



If needed, envelopes can be transported manually to the insert table or lower envelope track by means of handle **C**. To transport a mail set manually turn handle **B**.

4. Close the side cover.
 5. Tap **[x]** to reset the error and restart the job.
-

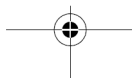

Folding Unit

When a stoppage occurs in the Folding Unit, remove the documents from the Folding Unit as follows:

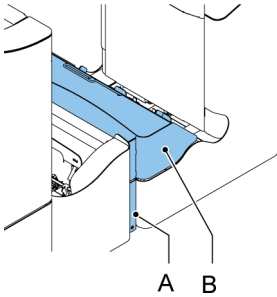

1. Push the lower end of the locking handle **A** to open the Folding Unit cover **B**.
2. Remove the documents from the Folding Unit.



Use the delivered pin to turn the rollers. The pin is delivered in the spare parts bag.



Remove the pin when finished.

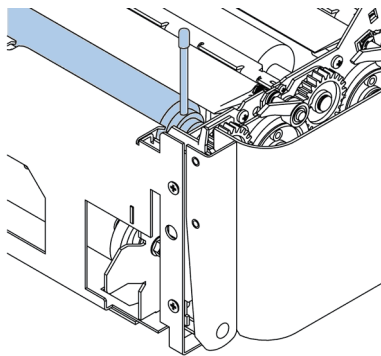

3. Close the Folding Unit cover.
 4. Tap **[x]** to reset the error and restart the job.
-

10

English

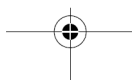

Feeding Unit

When a stoppage occurs in the Feeding Unit, remove the documents from the Feeding Unit as follows:

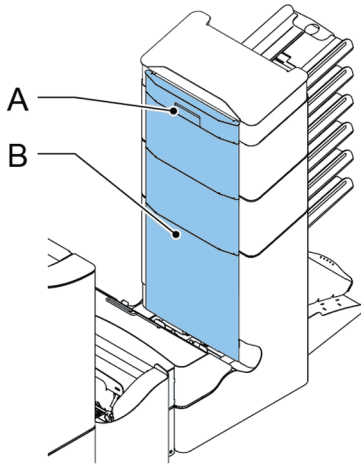

10

English

1. Pull the vertical transport hand grip **A** upward to open the vertical transport cover **B**.
 2. Remove the documents.
 3. Close the vertical transport cover **B**: push the bottom side of the cover towards the system, and next the top of the cover.
 4. Tap **[x]** to reset the error and restart the job.
-

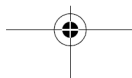

Collating Area

When a stoppage occurs in the collating area, remove the documents from the collating area as follows:

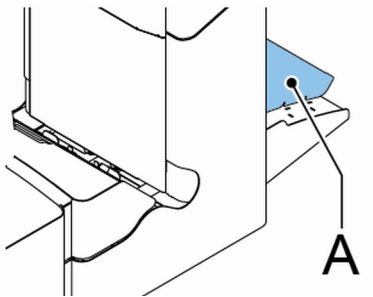

1. Lift and hold the collator arm **A**.
2. Remove the documents.
3. Lower the collator arm.
4. Tap **[x]** to reset the error and restart the job.

Thin Booklet Feeder

When a document is blocked in the separation unit the document can be removed as follows:

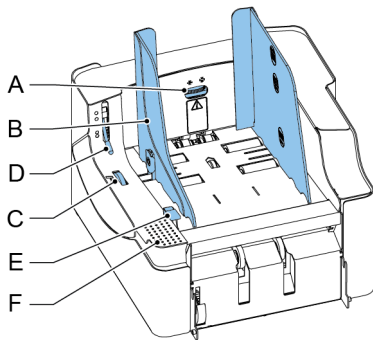

1. Open the separation by placing the release handle **D** in the upper position.

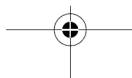

2. Remove the documents. If necessary open the feed unit:
 - Place your hand on the push down area **F**.
 - Push down the release handle **E**.

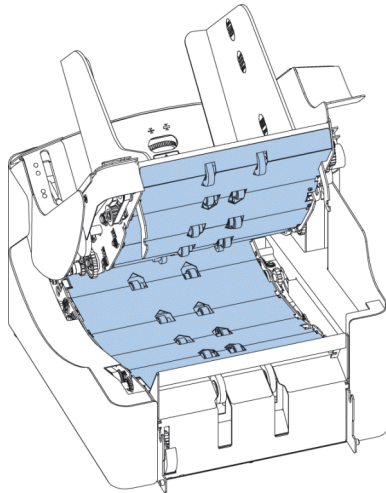

10

English

3. Remove the documents from the transportation area and from the rear side of the separation rollers.
4. Close the feed unit:
 - Place your hand on the push down area **F**.
 - Push the feed unit down until it locks into place.
5. Place release handle **D** of the separation unit in the closed position.
6. Tap **[x]** of the error message at the inserter to reset the error and restart the job.

Operator Troubleshooting

To resolve problems:

1. Write down the event message number that is shown in the message on the screen.
2. Try to solve the problem by consulting the [Troubleshooting Table](#) on page 137.
3. Switch the inserter off and on again, to verify system operation.
4. When the error still occurs contact your service organization.



When contacting the service organization, you will also be asked for the last error message and the software package version of the installed software. To determine the software package version, see [Software overview](#) on page 79.

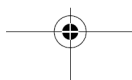

Troubleshooting Table

Symptom	Possible cause	Remedy	Reference
The system cannot be started after switching on.	System not connected to mains.	Connect the system to the mains.	-
	Fuse is blown.	Replace fuse below power switch.	-
	A cover is opened.	Close the covers.	-
System stops with envelope at insert position (flap not open).	Envelopes stacked reversed in the hopper.	Check envelope feed adjustments. Place envelopes correctly in hopper.	Loading Envelopes on page 66
	Envelope flap sticks.	Store envelopes according to specifications.	Envelope Specifications on page 144
	Wrong envelope type used (not according to specifications or job settings).	Change envelopes according to specifications.	Envelope Specifications on page 144
Envelopes are double fed.	Envelope separation not correctly set.	Adjust envelope separation.	Loading Envelopes on page 66 #
	Envelopes not placed properly in the hopper.	Check and replace if needed.	Loading Envelopes on page 66 #
Envelope stops skewed.	Side guides of the envelope hopper are set too wide.	Check side guides and adjust if needed.	Loading Envelopes on page 66 #
Envelopes are fed irregularly.	Hopper almost empty.	Refill hopper.	Loading Envelopes on page 66 #
	Separation set too narrow.	Adjust envelope separation.	Loading Envelopes on page 66 #
	Side guides set too narrow.	Check side guides and adjust if needed.	Loading Envelopes on page 66 #
	Envelope support not positioned correctly.	Reposition the envelope support.	Loading Envelopes on page 66 #

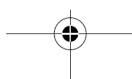

10

English

Flap is wrinkled and sometimes not opened.	Envelope not within specifications.	Check specifications and change envelopes if needed.	Envelope Specifications on page 144
	Flap sticks.	Store envelopes according to specifications.	Envelope Specifications on page 144
	Flap curled.	Envelopes stored or manufactured improperly.	Envelope Specifications on page 144
	Separation set too narrow.	Adjust envelope separation.	Loading Envelopes on page 66 #
Fingers are placed on top of the envelope.	Fingers adjusted too deep into the envelope.	Check fingers position, adjust if needed.	Adjusting the envelope insert fingers on page 37
	Envelope stops too early.	Check envelope stop position, adjust if needed.	Verifying the Insert Position on page 39
System stops while inserting (stoppage at the inserting point).	Fingers not correctly adjusted.	Check fingers position, adjust if needed.	Adjusting the envelope insert fingers on page 37
	Inserted document too long for used envelope.	Check fold settings.	Editing a job
	Envelope throat incorrect.	Check envelope specifications.	Envelope Specifications on page 144
	Envelope glued inside.	Eliminate faulty envelopes.	-
	Window not glued properly.	Eliminate faulty envelopes.	-



Flap not sufficiently moistened.	Water level low.	Check water level, refill if needed.	Filling the Sealing Liquid Reservoir on page 68
	Brushes dry.	Check brushes, replace if needed by the extra soaked set.	Clean and replace brushes
	Brushes dirty.	Check brushes, clean if needed.	Clean and replace brushes
	Moistening felt dry.	Check the moistening felt, refill water tray if needed.	Filling the Sealing Liquid Reservoir on page 68 #
	Moistening felt dirty.	Check the moistening felt, clean if needed.	Replace or clean moistening cloth
	Brushes worn out.	Replace brushes.	Clean and replace brushes
	Moistening felt worn out.	Replace moistening felt.	Replace or clean moistening cloth
Envelope not always ejected from sealer.	Inserted document too big.	Check fold settings, adjust if needed.	Editing a job
	Document not inserted deep enough.	Check adjustment of envelope stop position and fingers.	Verifying the Insert Position on page 39
	Sealing area dirty.	Clean sealing area.	Maintenance Schedule on page 123

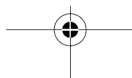

10

English

No document fed.	Feeder tray empty.	Refill feeder tray.	Loading documents standard feeder trays on page 58 Loading documents Production Feeder on page 61 Loading documents High Capacity Document feeder on page 63 Loading documents Thin Booklet Feeder on page 65
	Separation set too wide / too tight.	Adjust the separation.	Adjusting the Separation of Special Feeders on page 41 Adjusting Separation of Production Feeder on page 60 Adjusting the Separation of the Booklet Feeder pg 65
	Side guides set too narrow.	Adjust the side guides.	Adjusting the side guides standard feeder trays on page 57 Adjusting the side guides Production Feeder on page 59 Adjusting the side guides High Capacity Document Feeder on page 62 Adjusting the side guides Thin Booklet Feeder on page 64

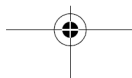

Skewed documents fed.	Side guides set too wide.	Adjust side guides.	Adjusting the side guides standard feeder trays on page 57 Adjusting the side guides Production Feeder on page 59 Adjusting the side guides High Capacity Document Feeder on page 62 Adjusting the side guides Thin Booklet Feeder on page 64
Double documents fed.	Separation set too wide.	Adjust the separation.	Adjusting the Separation of Special Feeders on page 41 Adjusting Separation of Production Feeder on page 60 Adjusting the Separation of the Booklet Feeder on page 65
Document set not correctly inserted.	Insert position not correct.	Check insert position.	Verifying the Insert Position on page 39
	Insert fingers not correctly positioned.	Check insert finger position.	Adjusting the envelope insert fingers on page 37
Address not readable from window	Address position not correctly defined.	Check address position.	Adjusting the address position on page 36



English

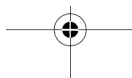

11 Specifications

Technical Specifications

Model	FD6606 Folder and inserter system for medium office use.
Type	4,300 inserts per hour, depending on application.
Theoretical max. speed	100V AC/50Hz/4.0 Amps.
Power consumption	115V AC/50/60Hz/4.0 Amps. 230V AC/50Hz/2 Amps.
Voltage tolerance	100V: +6% / -10% 115V: +6% / -10% 230V: +10% / -10%
Fuse	100/115 Vac: T 5.0 A, 125 V . Time lag, 5.0 Amps. rated current, 125 V. 230 Vac: T 3.15 A H, 250 V. Time lag, 3.15 Amps. rated current, high breaking capacity, 250 V.
Approvals	EMC Certificate conform EMC-Directive. FCC Certificate conform 47CFR, part 15 CB Certificate conform IEC 60950-1 UL Listed I.T.E. (Information Technology Equipment) Conform UL-IEC 60950-1, file E153801 Conform NEN-EN-IEC 60950-1 and derivatives.
Noise Level	<70 dBA (according to ISO 11202)
Operating temperature	10°C - 40°C (50°F-104°F)
Humidity	30%-80%



English

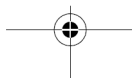

Hopper and Feeder Capacity

Envelope hopper	325 envelopes (80 g/m ²)
Document feeder tray	325 sheets (80 g/m ²)
High Capacity Document Feeder tray	725 sheets (80 g/m ²)

Configuration Dimensions

	2 stations	3/4 stations	5/6 stations
Height	820 mm (32.3 inch)	820 mm (32.3 inch)	920 mm (36.2 inch)
Width*	460 mm (18.1 inch)	460 mm (18.1 inch)	460 mm (18.1 inch)
Length	1500 mm (59.1 inch)	1500 mm (59.1 inch)	1500 mm (59.1 inch)
Weight	118.5 kg (261 lbs)	124.2 kg (274 lbs)	140.0 kg (308 lbs)

* Width with catch tray 750 mm/29.5 inch

Document and Insert Specifications

Paper quality	<p>Minimum 60 g/m² (15 lb bond)</p> <p>Maximum 250 g/m² (62.5 lb bond), when folded max. 170 g/m² (42.5 lb bond)</p> <p>Booklets up to approximately 2 mm (0.08 inch) thickness, depending on stiffness</p>
Paper size	<p>Minimum width: 130 mm (5.1")</p> <p>Maximum width: 242 mm (9.5"), when folded 230 mm (9.1")</p> <p>Minimum length: 90 mm (3.5")</p> <p>Maximum length: 356 mm (14")</p>

11

English

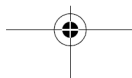

Folding capacity

V-fold - 10 sheets (max. 80 g/m²)
 C-fold/Z-fold - 8 sheets (max. 80 g/m²)
 Double V-fold - 4 sheets (max. 80 g/m²)

Envelope sizes

Standard BRE (Business Reply Envelopes)

Envelope quality

Minimum 80 g/m² (20 lb bond)
 Maximum 120 g/m² (30 lb bond)

Envelope and Document Set Specifications

11
 English

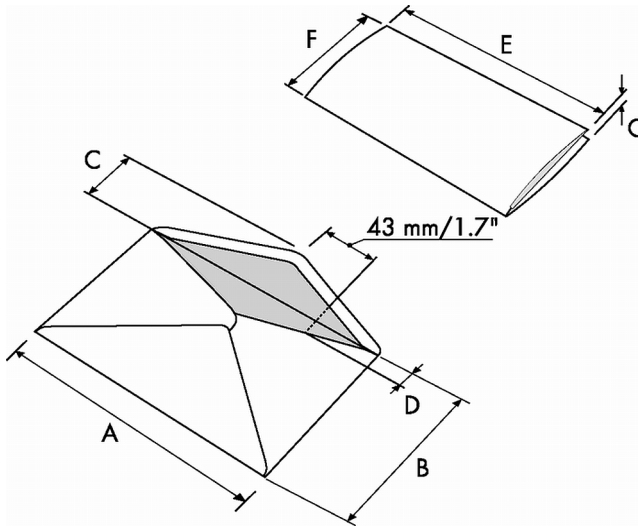

	A	B	C	D	E	F	G
Minimum size	160 mm 6.3"	90 mm 3.5"	32 mm 1.25"	10 mm 0.4"	-	84 mm 3.3"	60 g/m ²
Maximum size	248 mm 9.7"	162 mm 6.38"	B-32 B-1.25	75 mm 2.9"	A-12* A-0.47**	B-6 B-0.2	2.5 mm 0.1"

* Booklets up to approximately 2 mm (0.08 inch) thickness, depending on stiffness

** When insert is more than 1 mm (0.04 inch): A-15 mm / A-0.6 inch

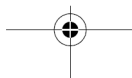

Remarks:

- The specification of the paper handling equipment is often wider than that of the envelopes and documents handled. The condition of material handled will limit the specified environmental conditions.
- We recommend that materials to be handled are stored at a temperature of 20°C (68°F) with a relative humidity factor of 50%. If difference in temperature occurs between store room and mailing area, the material has to be stored near the machine at least 24 hours before use.
- Self-copying paper may cause rubber parts to wear quicker. The rubber used in this machine has the best resistance to Wiggins Teape material.

Production Feeder Specifications

Model	FD 6606-00
Type	High capacity feeder
Theoretical max. speed	see Technical Specifications
Power consumption	Low voltage supplied by the inserter system.
Approvals	EMC Certificate conform EMC-Directive. FCC Certificate conform 47CFR, part 15. UL Listed I.T.E. (Information Technology Equipment), conform UL-IEC 60950-1, file: E153801. Conform NEN-EN-IEC 60950-1 and derivatives.
Height	210 mm (8.3 inch)
Width	285 mm (11.2 inch)
Length	425 mm (16.7 inch)
Weight	5.05 kg (11.1 lbs)
Noise level	see Technical Specifications
Operating temperature	10°C - 40°C (50°F-104°F)
Humidity	30%-80%
Feed tray capacity	1200 sheets A4 80 gr. 320x Business Reply Envelopes



English

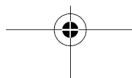

Document / BRE insert specifications See [Document Specifications](#) on page 143 and [Envelope Specifications](#) on page 144

Thin Booklet Feeder Specifications

Model	FD 6606-15
Type	Booklet feeding device for medium office use
Theoretical max. speed	see Technical Specifications
Power consumption	100V AC/50Hz/2.0 A 115V AC/50/60Hz/2.0 A 230V AC/50Hz/1 A
Approvals	EMC Certificate conform EMC-Directive. FCC Certificate conform 47CFR, part 15. CB Certificate conform IEC 60950-1. UL Listed I.T.E. (Information Technology Equipment), conform UL-IEC 60950-1, file: E153801. Conform NEN-EN-IEC 60950-1 and derivatives.
Height	407 mm (16.0 inch)
Width	440 mm (17.3 inch)
Length	500 mm (19.7 inch)
Weight	30.5 kg (67.2 lbs)
Noise level	see Technical Specifications
Operating temperature	10°C - 40°C (50°F-104°F)
Humidity	30%-80%
Paper quality, feed unit	Minimum 80 g/m ² (15 lb bond) single sheets (max. 500 sheets) Booklets up to approximately 2.5 mm (0.09") thickness

11

English

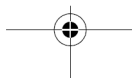

Paper quality, transport unit	Minimum 60 g/m ² (15 lb bond) Thickness up to 3.2 mm (0.13")
Document size	Minimum width: 120 mm (4.7") Maximum width: 243 mm (9.6") Minimum length: 90 mm (3.5") Maximum length: 162 mm (6.4")
Hopper tray capacity	Booklets with a tough cover: maximum height 250 mm Booklets with a weak cover: maximum height 150 mm Single sheets (80 gr/m ²): maximum height 50 mm

High Capacity Envelope Hopper Specifications

Model	FD 6606-30/EF-4
Type	High Capacity Envelope Feeder (HCEH)
Power consumption	24V-1A max.
Approvals	EMC Certificate conform EMC-Directive. FCC Certificate conform 47CFR, part 15. CB Certificate conform IEC 60950-1. UL Listed I.T.E. (Information Technology Equipment), conform UL-IEC 60950-1, file: E153801. Conform NEN-EN-IEC 60950-1 and derivatives.
Height	200 mm (7.9 inch)
Width	375 mm (14.8 inch)
Length	670 mm (26.4 inch)
Weight	22 kg (48.4 lbs)
Noise level	see Technical Specifications
Operating temperature	10°C - 40°C (50°F-104°F)



English



Humidity	30%-80%
Envelope sizes	See Envelope Specifications on page 144
Feeder capacity	max. 1000 envelopes

High Capacity Conveyor Belt Specifications

Model	FD 6606-25/CS-2
Type	High Capacity Conveyor Belt (HCCB)
Power consumption	24V-1A max.
Approvals	EMC Certificate conform EMC-Directive. FCC Certificate conform 47CFR, part 15. CB Certificate conform IEC 60950-1. UL Listed I.T.E. (Information Technology Equipment), conform UL-IEC 60950-1, file: E153801. Conform NEN-EN-IEC 60950-1 and derivatives.
Height	440 mm (17.3 inch) (including support legs)
Width	315 mm (12.4 inch)
Length	1310 mm (51.6 inch)
Weight	19,5 kg (42.9 lbs)
Noise level	see Technical Specifications
Theoretical max. speed	between 20 mm/s and 150 mm/s
Operating temperature	10°C - 40°C (50°F-104°F)
Humidity	30%-80%
Document / envelope size	Minimum length 80 mm (3.2 inch) Maximum width 260 mm (10.2 inch)
Max. capacity to be transported	1000 envelopes. with a maximum weight of 5 kg (11 lbs)



English

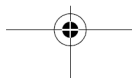

12 Terminology

Terminology

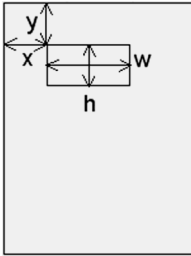
Term	Description
Address carrier	The address carrier is the document that carries the address of the person for who the mail-set is meant. The address must remain visible while enclosures are added and the document-set is folded. The fold type and selected envelope must ensure that the address is visible behind the window in the envelope. For personalized mailings there is always an address carrier present as long as envelope printing is not supported. Normally there is one address carrier.
Address position	 <p>Position of the address on the address carrier, measured from the upper left corner. The address position consists of a horizontal x coordinate, a vertical y coordinate, a horizontal width w and a vertical height h.</p>
Automatic	The feature of an Inserting System to automatically determine its Job settings by measuring the sizes of documents and envelope. From all Feeders that are loaded one sheet will be taken. Based on the maximum document length (which is also the length of the documentset) and the length of the envelope the fold type is determined.
Automatic job	A job that is created with the Automatic functionality.
Barcode Reading (BCR)	Barcode Reading is intended for reading and interpreting printed barcodes. The codes give information to the Inserting system about how to build-up and handle a set.
Business Reply Envelope (BRE)	Envelope included in outgoing mail-sets for addressee response purposes.

12

English

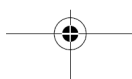

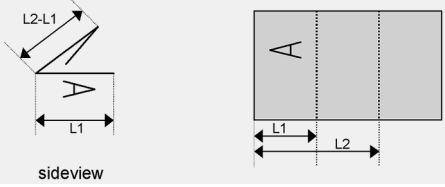
C-fold	<p>Fold type in which a document-set is folded twice in which the folded flaps are on top of each other. This fold is illustrated in the picture below.</p>  <p>The position of both folds is adjustable. Synonym: Letter fold.</p>
Clear	The function of an inserting system in which all mail-sets in progress are finished and the document path is left empty.
Conveyor stacker	Stacks up filled envelopes from the system.
Daily Mail	Capability of an inserting system to manually insert mail-sets one by one into the system, which are then inserted into an envelope. Optionally, depending on settings, additional enclosures can be added and the mail-set can be folded. This function is intended for small amounts of mail that each can have a different build-up.
Document	A document is one of the components of a mail-set. A document can consist of one or more sheets. Documents can be divided into address carriers and enclosures. For personalized mailings there is always one address carrier and an optional number of enclosures.
Document-set	The document-set is the physical collection of address carrier and enclosure(s) that is under production in the Inserting System. The document-set is completed during production and is to be inserted in the envelope. The number of enclosures can range from 0 to the limit opposed by the number of available Feeders. Once the document set has been inserted into an envelope it is called mail set.
Double Feed Control (DFC)	Double Feed Control is the sensor that measures the thickness of a sheet to check if the inserting system does not accidentally take more sheets than intended. DFC sensors exist on Feeders (double sheet detection). Currently DFCs on Neopost inserting systems perform relative measurements, which means that they need a cycle to 'learn' the thickness of a sheet. Also the length of the document is measured so partly overlapping sheets will be detected.
Double parallel fold	See double V-fold.

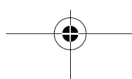

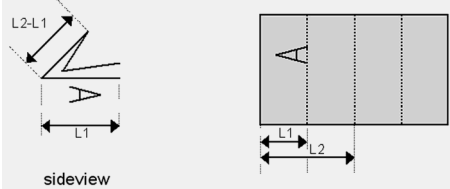
<p>Double V-fold</p>	<p>The double V-fold is a type of fold where the document is first folded halfway and the resulting folded set is again folded halfway. This fold is illustrated in the picture below.</p>  <p>The position of both folds is adjustable. Synonym: double parallel fold.</p>
<p>Envelope</p>	<p>The envelope is the packaging of a mail set. Window envelopes are envelopes that have a transparent section through which the address on the address carrier can be read. Besides the normal top-closing window envelopes there are also bottom-closing envelopes.</p>
<p>Extended Folding Unit</p>	<p>Option, makes bottom address applications and short folds possible.</p>
<p>Face down</p>	<p>Situation in which the front of a sheet is facing downwards when placed in a document feeder.</p>
<p>Face down leading</p>	<p>Situation in which the front of a sheet is facing downwards and the top of the sheet is closest to the separation unit in a document feeder.</p>
<p>Face down trailing</p>	<p>Situation in which the front of a sheet is facing downwards and the bottom of the sheet is closest to the separation unit in a document feeder.</p>
<p>Face up</p>	<p>Situation in which the front of a sheet is facing upwards when placed in a document feeder.</p>
<p>Face up leading</p>	<p>Situation in which the front of a sheet is facing upwards and the top of the sheet is closest to the separation unit in a document feeder.</p>
<p>Face up trailing</p>	<p>Situation in which the front of a sheet is facing upwards and the bottom of the sheet is closest to the separation unit in a document feeder.</p>
<p>Feeder</p>	<p>A Feeder is a Module for the input of documents to the inserting system. The Feeder separates documents sheet by sheet from the stack of documents in the feed tray.</p>
<p>Feeder linking</p>	<p>The ability to load two feeders with the same document type where the Inserting System automatically switches to a second feeder when the first feeder is empty and vice versa. In the mean time the first feeder can be refilled, so the inserting system can keep running without having to stop for refilling the feeders.</p>
<p>Feed tray</p>	<p>Part of the feeder that contains the stack of documents.</p>

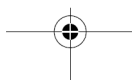

Flexcode OMR	An OMR code for which the meaning of the OMR marks can be programmed in a dedicated way for a specific customer. This is normally used to support the OMR codes from other suppliers.
Feeding Unit	The Feeding Unit is the feeding part of the system.
High Capacity Document Feeder (HCDF)	Optional feeder with a capacity for up to 725 sheets.
High Capacity Vertical Stacker (HCVS)	Optional stacker that is mounted on the exit of the system, to stack filled envelopes.
Insert	<ul style="list-style-type: none"> • An insert is the action of inserting a document-set into an envelope. • For native English speaking customers an insert is also a short, not to be folded document, usually an enclosure.
Inserter	An Inserter is the Module where the document-set is inserted into the envelope, the envelope is closed and if necessary sealed.
Inserting system	The system of all the Modules that cooperate to perform the inserting function (accumulate document-set, fold and insert) and have a single point of control.
Divert Deck	To avoid stoppages the Divert Deck diverts duplicate or faulty documents before folding them while the system is still running.
Job	<p>A job is an actually produced collection of mail-sets based on a certain Job Definition at a certain point in time for a specific purpose. It consists of:</p> <ul style="list-style-type: none"> • The Job definition used for the production • Information about the batch size
Job counter	The counter that registers the number of mail-sets that is produced as part of a specific job.
Letter fold	See C-fold.
Linking	See Feeder Linking.

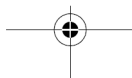

Loc	The Loc is the unit in the system that transports the envelope just after the document was inserted. It is called Loc (short for locomotive) as the early developments had a straight cover and a number of transportation rollers sticking out. This made it look like a locomotive from the side. In the current systems the loc also carries the brush holder and sealing rollers.
Production Feeder	Feeder with high capacity feed tray (e.g. 1200 sheets A4 80gr).
Multifeed	The feature of an Inserting System in which more than one sheet is taken from a Feeder.
OMR	Optical Mark Recognition
OMR code definition	Standard 1-track OMR code definition. Specifies the amount of reading marks used and the functionality linked to each of them (how each should be interpreted).
Online Services (OLS)	The ability to connect the system to a central server for updates and other communication.
Operator	The person operating a document system.
Optical Mark Recognition (OMR)	Optical Mark Recognition is intended for reading and interpreting printed codes. These codes are one or more black marks which are read from a document. These marks give information to the Inserting system about how to build-up and handle a set.
Folding Unit	The Folding Unit can fold up to 10 pages.
Reading error	Condition in which the system could not reliably read or interpret the OMR reading marks or barcode from a sheet.
Reading marks	Marks added to documents containing finishing instructions that can be identified by a reading head and interpreted according to the used OMR code definition.
Remote diagnostics	The feature that makes it is possible to analyze a problem on an Inserting System from a remote location.
Service engineer	Technical engineer whose task it is to resolve problems with systems in the field. Besides dealing with problems, service engineers are also responsible for preventive maintenance.
Single fold	See V-fold.
Stop counter	Counter which sets the amount of envelopes to be filled. After filling this amount of envelopes the system will stop (even during a clear).
Supervisor	Person who is responsible for the technical state of the machine. Normally a supervisor has access to programming functions, which are restricted for standard users.

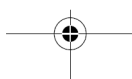

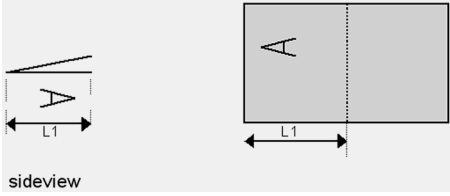
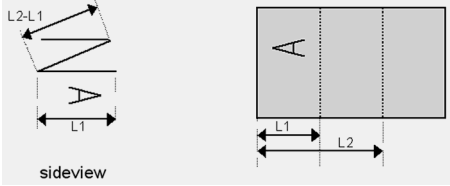
Test run	<p>A test run is intended to validate the settings of the Inserting System:</p> <ul style="list-style-type: none"> • Inspect and adjust the stop position of the envelope. • Check the fold settings for one set. • Check if the address is correctly positioned behind the envelope window.
Thickness detection	Checks the thickness of the document set. If the thickness is less or more than the set value an error message is displayed.
Tray	Contains a stack of paper for a printer or inserter. This paper is supplied to the machine for further processing.
V-fold	<p>A V-fold implies the document/set is folded once. The fold-position is adjustable. This fold is illustrated in the picture below:</p>  <p>sideview</p> <p>Synonym: Single fold.</p>
Booklet Feeder	Booklet feeding device.
Vertical transport	The vertical transport section between feeders and collator.
Z-fold	<p>A Z-fold means that a document is folded twice in such a way that each folded flap is on a different side of the folded document, resulting in a Z-shape. This fold is illustrated in the picture below.</p>  <p>sideview</p> <p>The position of both folds is adjustable. Synonyms: zigzag fold</p>

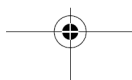

Index

B

belt 72
Belt 148
brushes 68, 123, 124, 137
Brushes 137

C

can 1, 3, 4, 9, 11, 13, 19, 21, 28, 30,
34, 35, 58, 60, 64, 65, 69, 81, 84, 93,
95, 100, 101, 104, 108, 112, 113, 114,
115, 117, 118, 119, 122, 127, 130, 135,
149
catch tray 6, 17, 143
control panel 6, 7, 94
counter 13, 29, 31, 34, 149
Counter 11, 13, 31, 78, 149
cover 6, 130, 137, 146, 149

D

Date 83
diagnostics 88, 149

E

envelope hopper 4, 70, 131, 137
Envelope hopper 143
Envelope Hopper 4

F

feeder 3, 4, 11, 13, 15, 19, 21, 26, 34,
47, 56, 57, 58, 60, 63, 66, 100, 104,
108, 119, 137, 143, 145, 149
Feeder 11, 13, 15, 137, 143, 147, 149
Folder 142

H

hopper 137
Hopper 137, 146

K

keyboard 11, 82

L

label 104

Label 104
LAN 99

M

menu 1, 9, 12, 13, 74, 78, 79, 80, 81,
83, 84, 90
messages 127

O

off 11, 13, 72, 84, 90, 119
Off 7
Online Services 149
operator 16, 119, 123, 127
Operator 74, 149

P

power 6, 69, 123, 137
Power 142, 145, 146, 147, 148
processing mail 3
Processing mail 58

R

rollers 6, 123

S

sensors 88, 90, 123, 126
side guide 6
stacker 4, 6, 69, 100, 104, 108, 122, 149
Stacker 4, 149
standard 82, 100, 112, 137
Standard 143, 149
supervisor 12, 51, 115, 149
Supervisor 76, 95, 149

T

task 149
text 101
thickness 3, 13, 16, 84, 104, 108, 122,
143, 144, 146, 149
Thickness 30, 122, 146, 149
time 58, 93, 149
Time 83, 142